

新メイプルタウン物語

パムタウン編

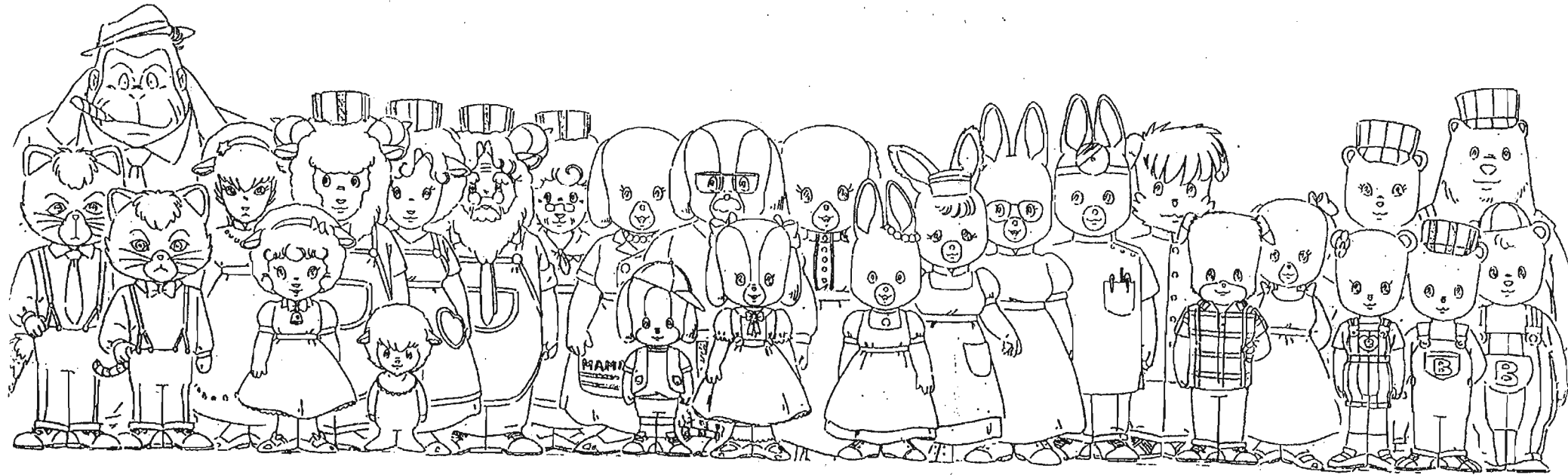

キャラクター設定集

ローリィと同年代のキャラは
大きさに無理がなければ
なるべくハイライトを2つ以上
入れて下さい

基本的にみっくろです。
下唇(はなっけれと)の下の
線はありますが口の形によらず
無視してもかまいません。

靴にあるハイライトは
なるべく省略しないで下さい

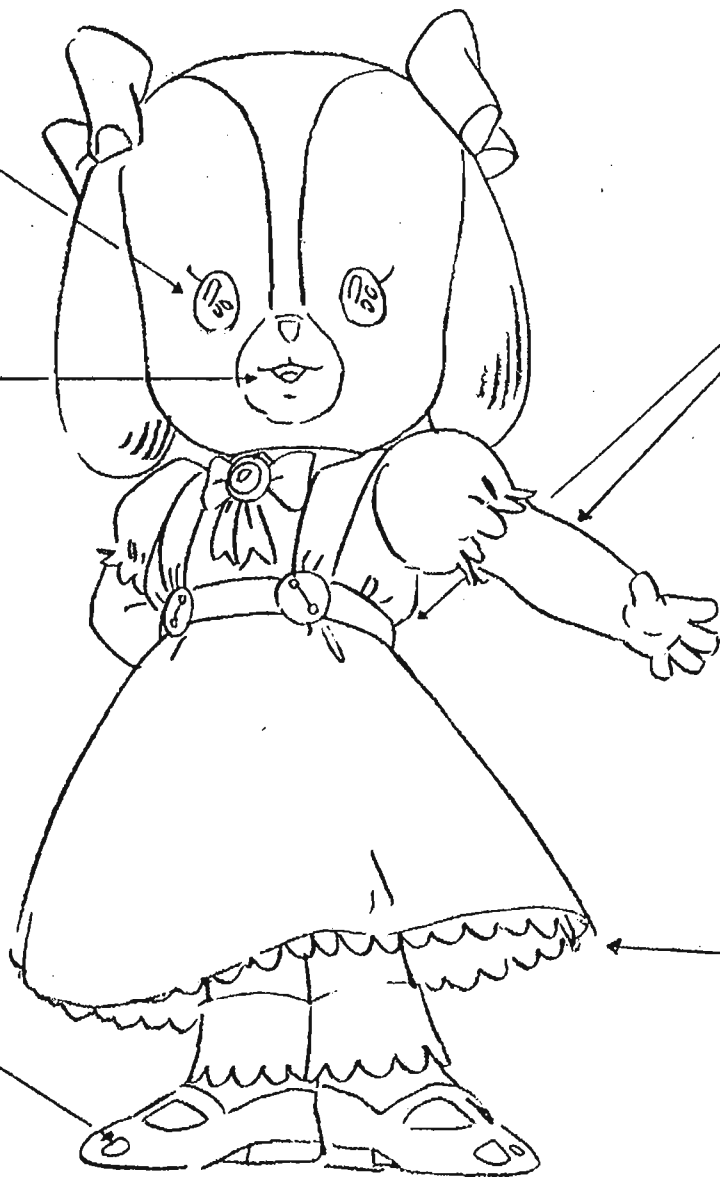

ローリィのウエストと腕は
パーティより細いですが
パーティに比べて頭でっかちに
見えるので、ほとほとに
して下さい。

スカートはパーティより
短いものが多いので描き
分けに注意



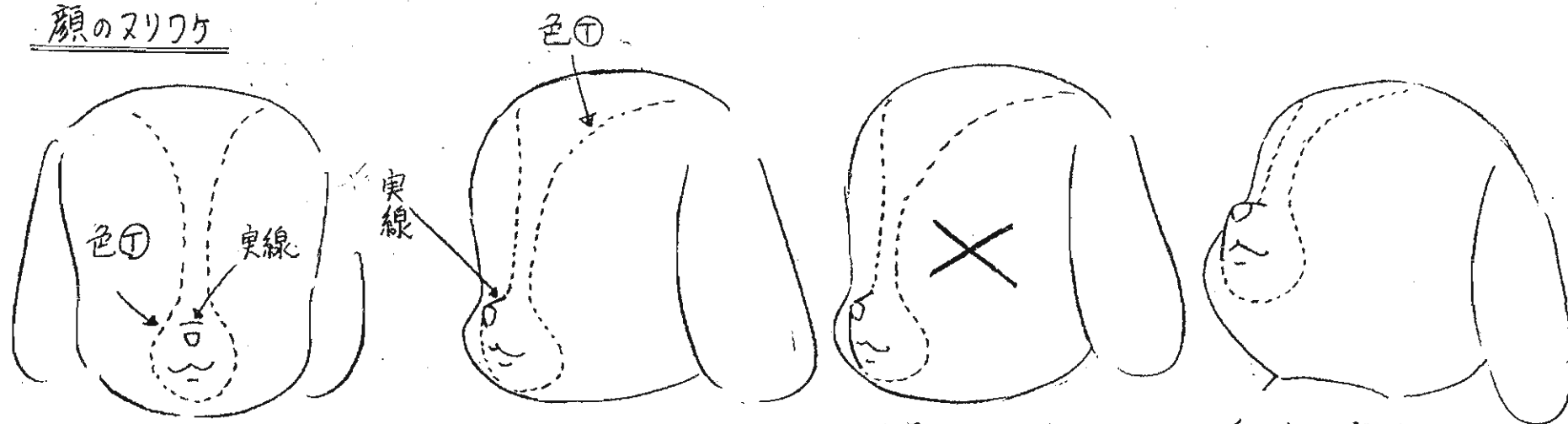

顔のヌリワケ



なるべくこうしない下さい

鼻の先が顔の輪郭からはみ出る場合はO.K.

目の種類

	細くて長い	 こういうもの あります
	上より太くて短いか 明き目よりやや長い	
	明き目	

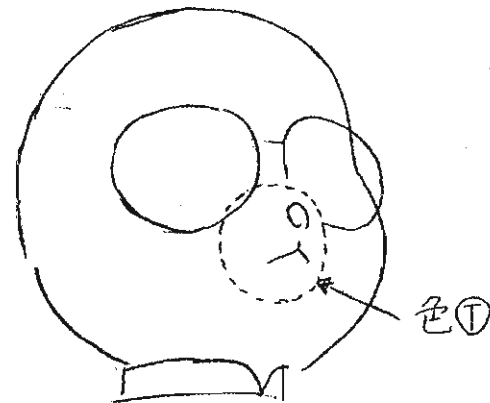

本当は おかしいけれど
こんな時色トレス

コッカー
ファミリー

パイカ
ファミリー

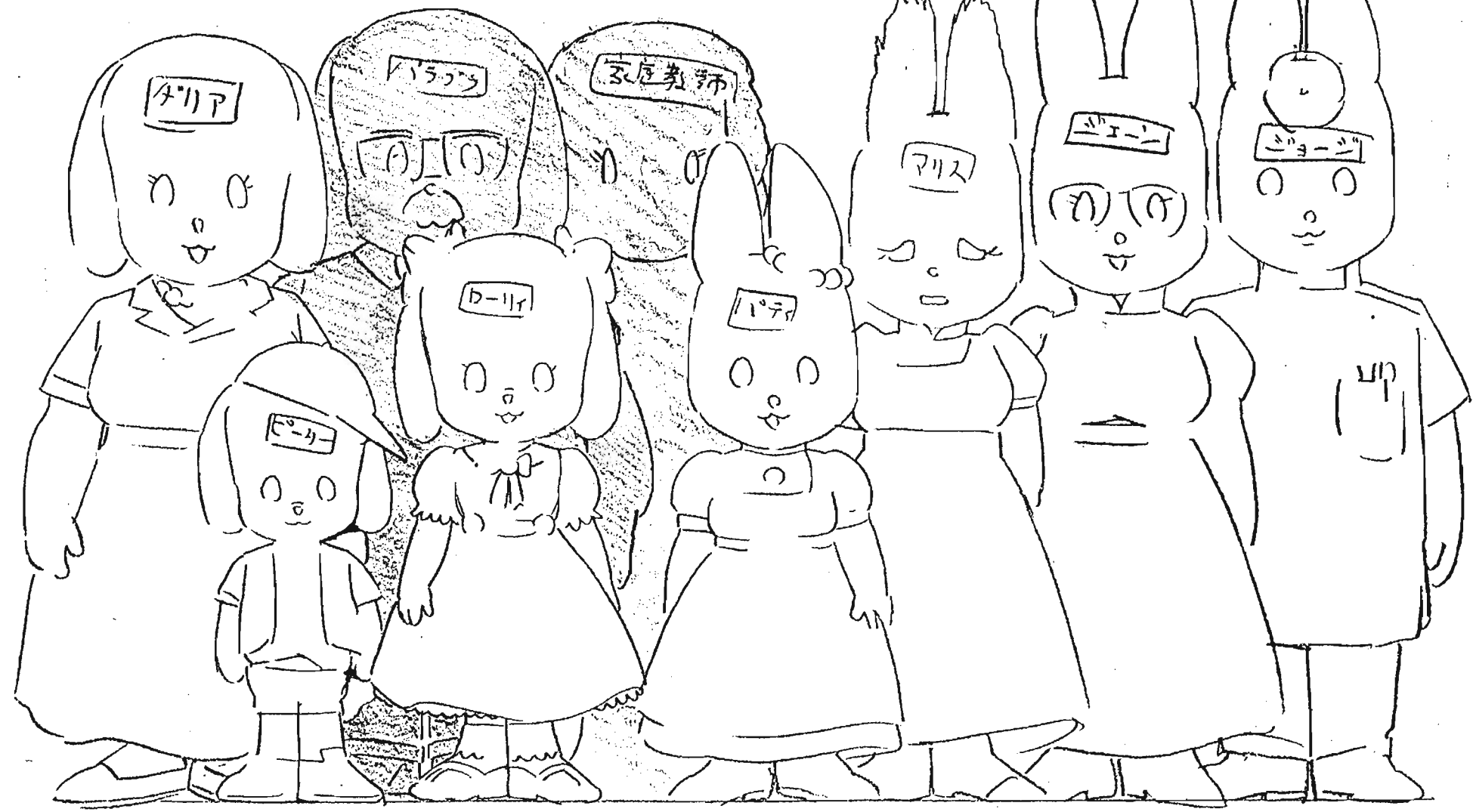

ロ-114. コッカー ①

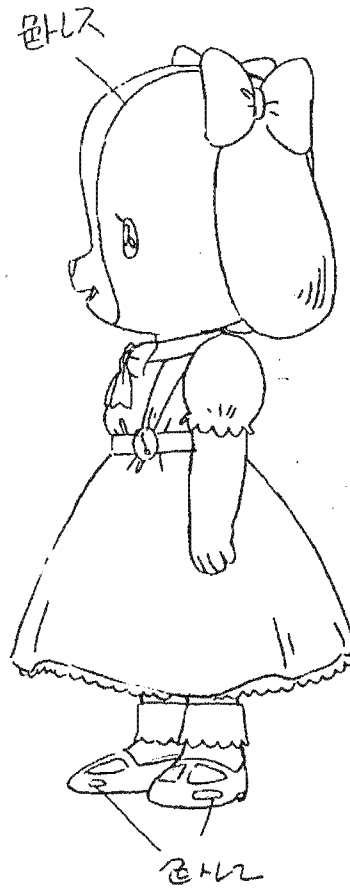
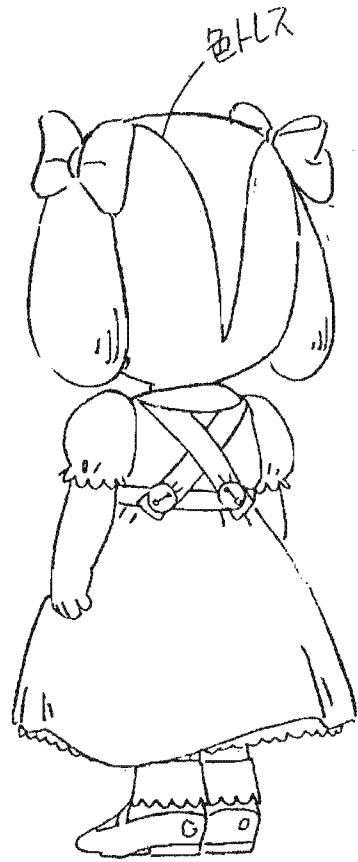
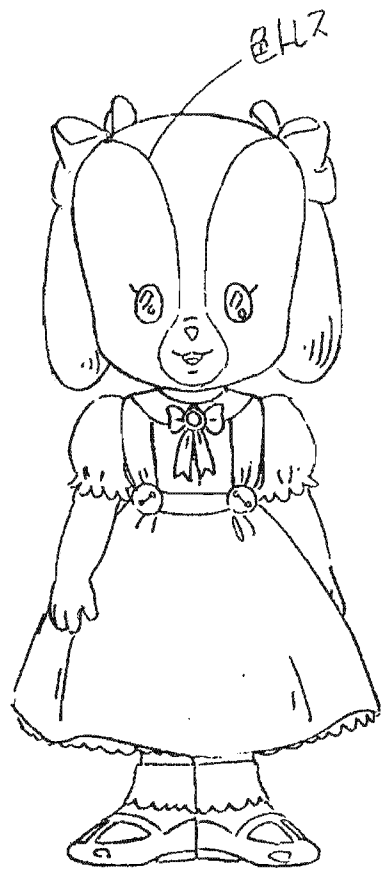

□-1/4 コーカ- ②

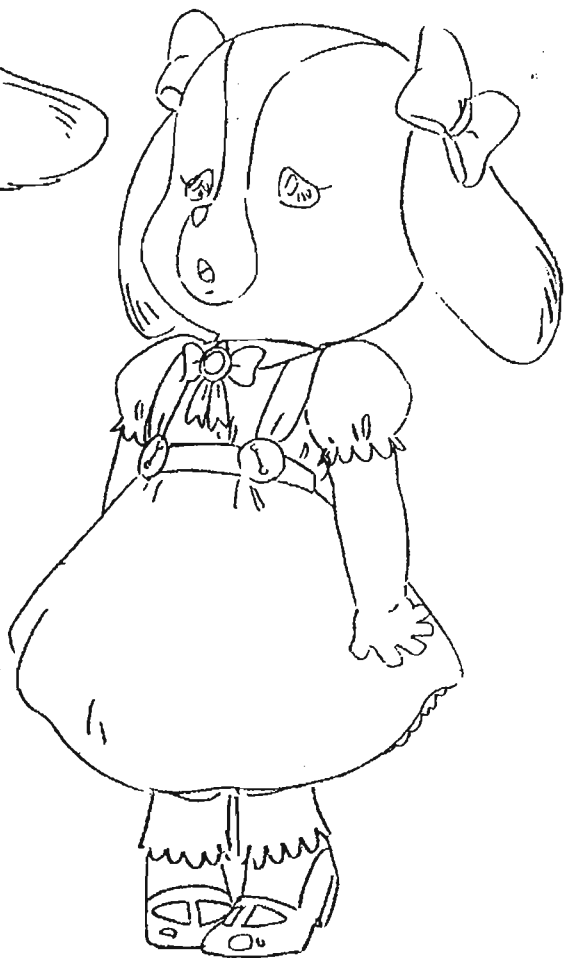

ローリィ コッカー ③

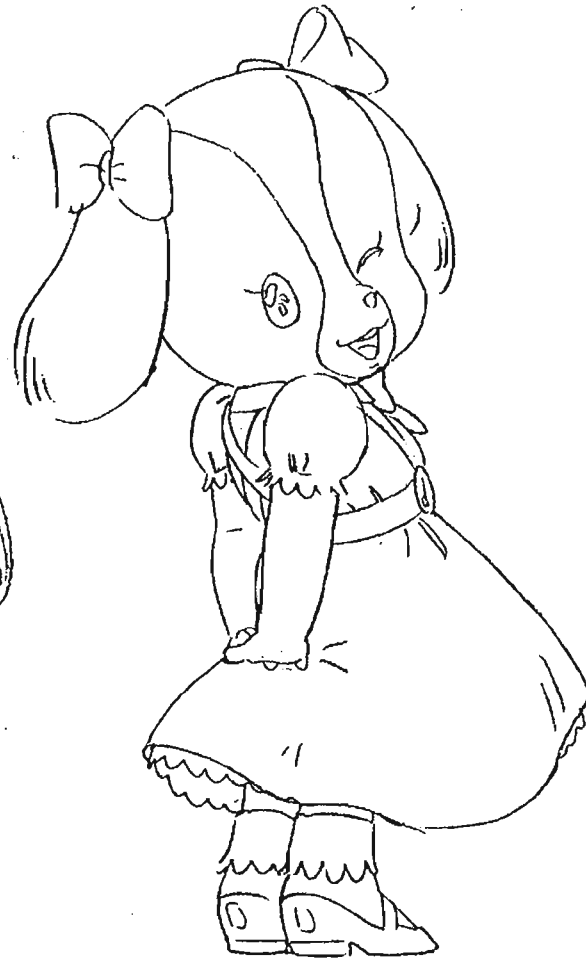

ロ-1/1: コッタ- ④

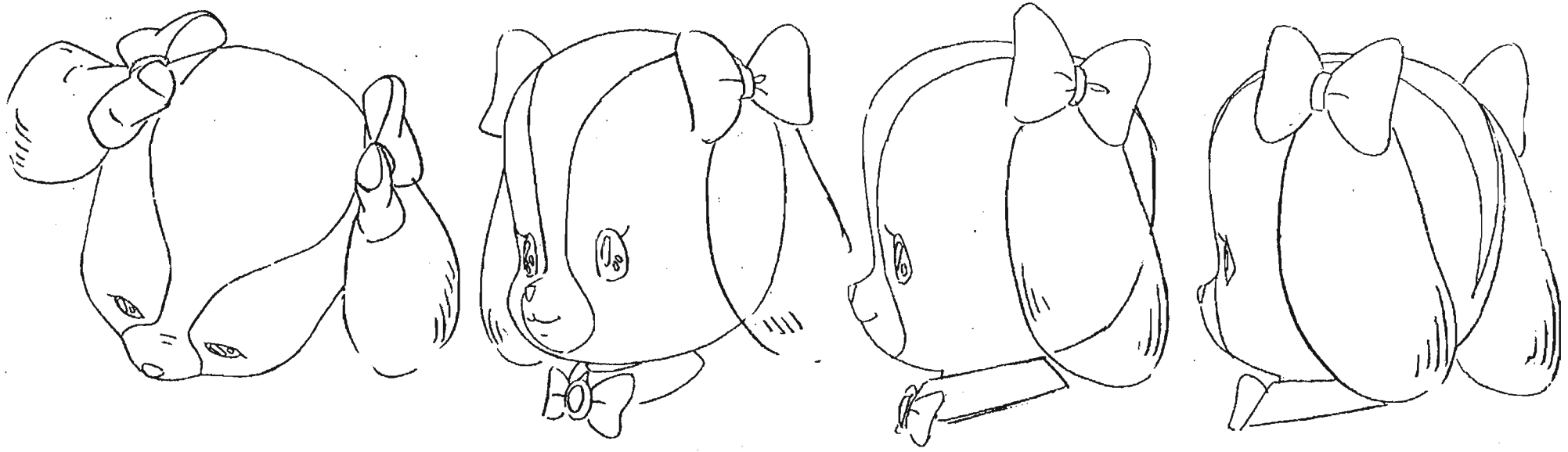

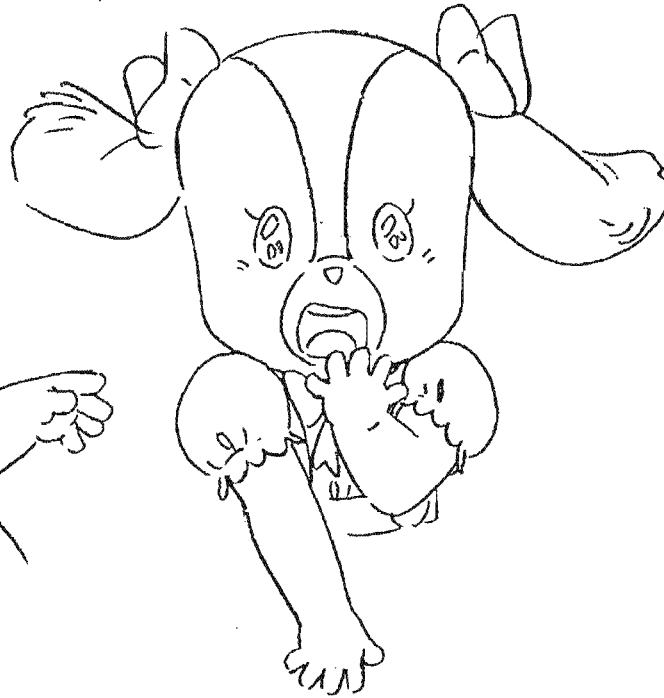
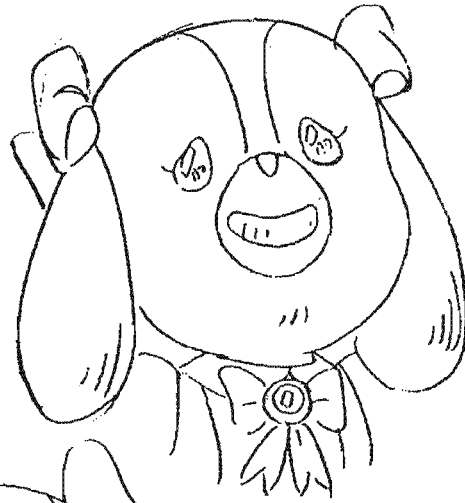

□-1/1 - コ-カ-⑥

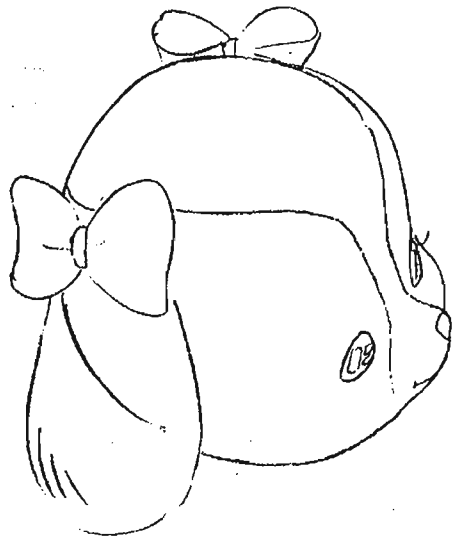
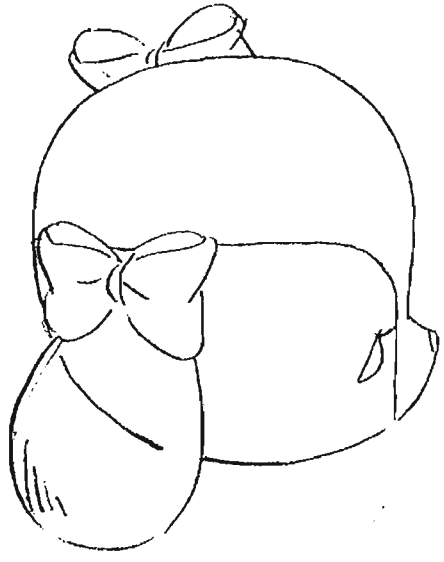
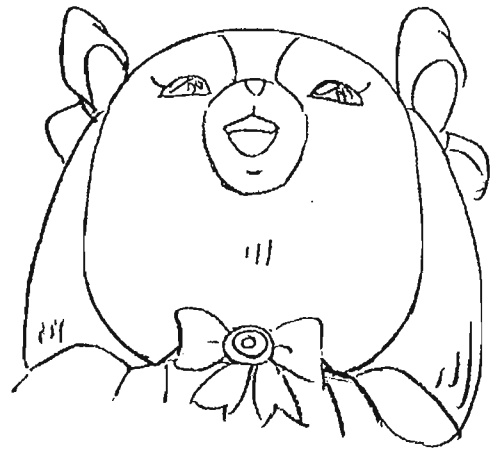
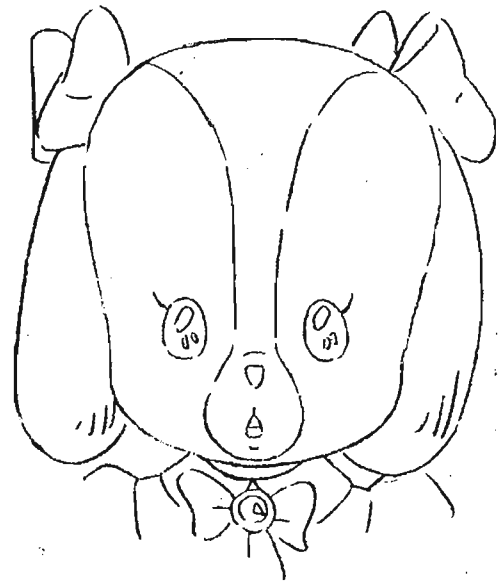
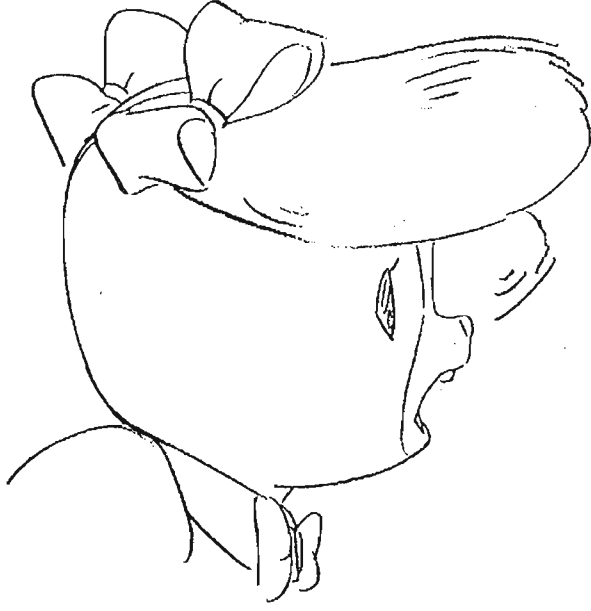

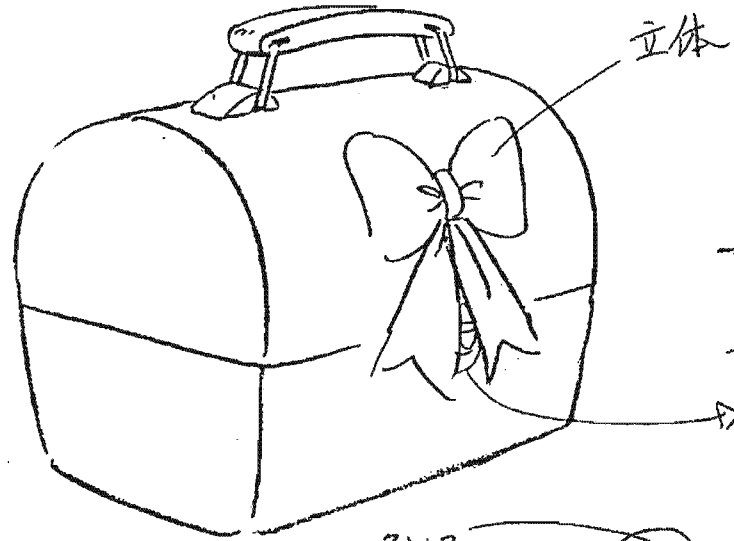

立体

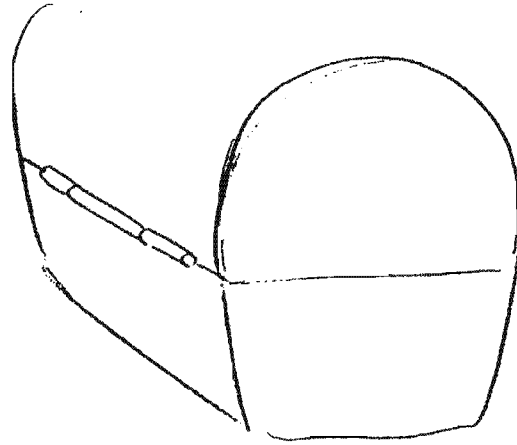
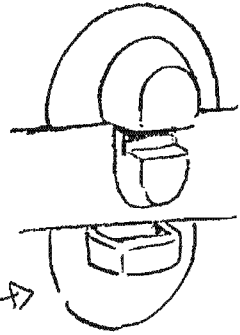

ロンクの時
色トレスのみ

色トレス

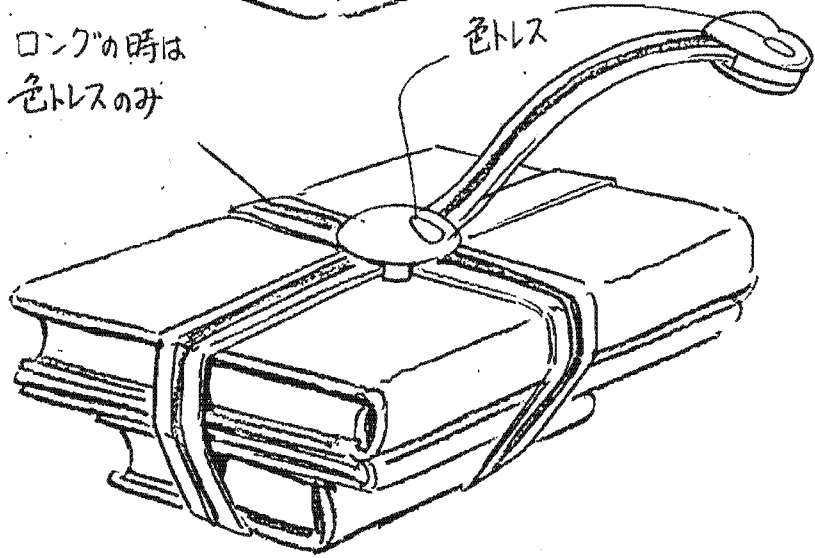

金具

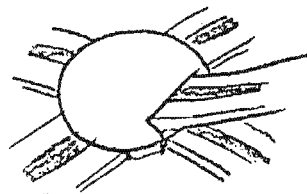
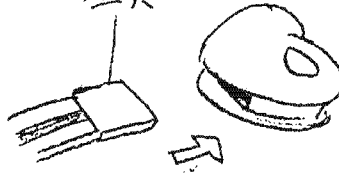

ローリーの
通学バスケット

メイプルタウン物語
南の国のパームタウン

11/27 新

12-11の帽子

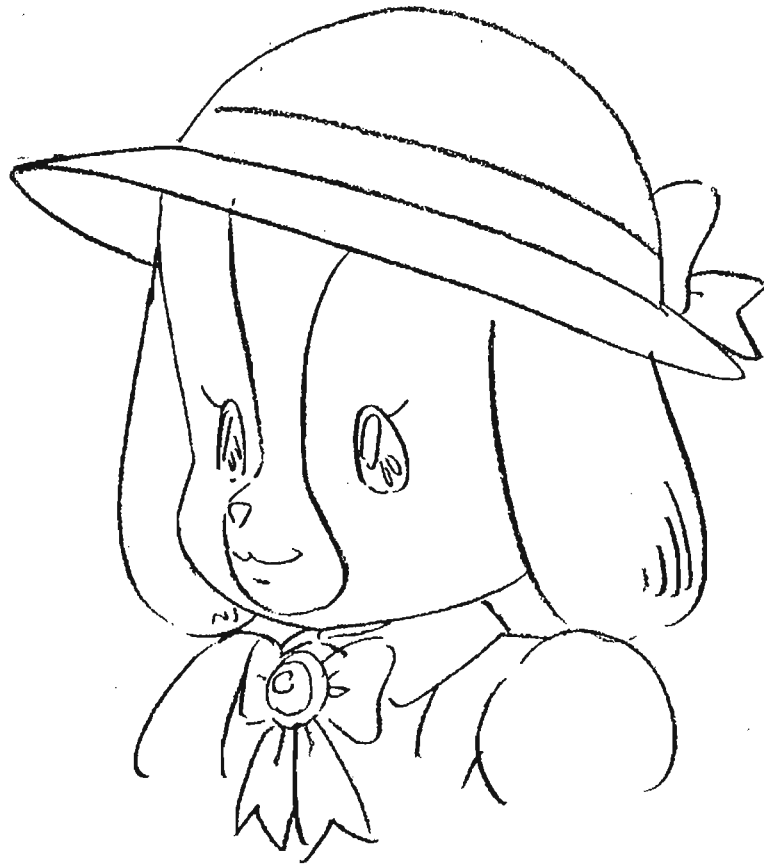

メイプルタウン物語
南の国のパームタウン

ピーター・ジョーカー ①

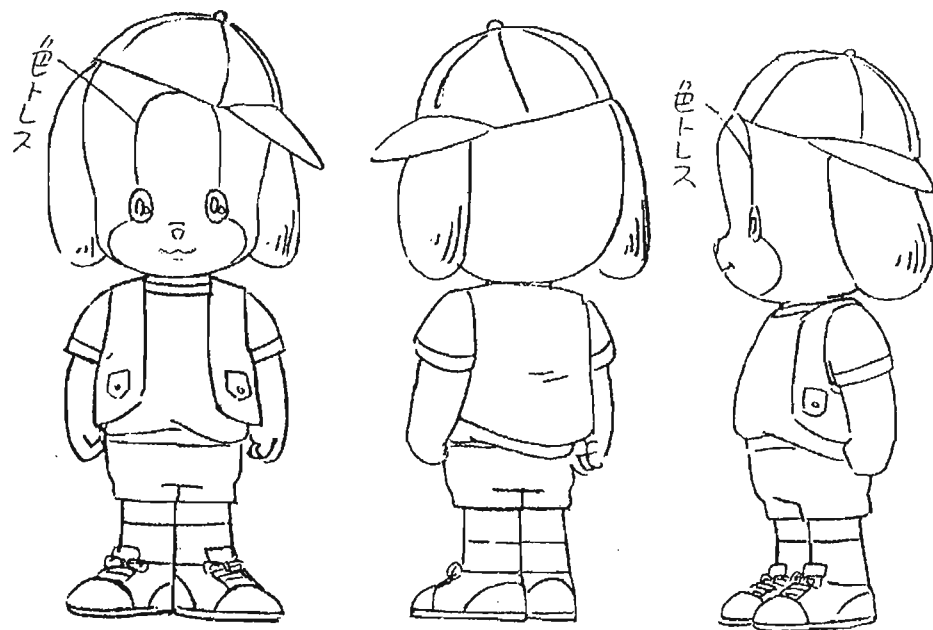

ピ-ダ-ゴカ-②

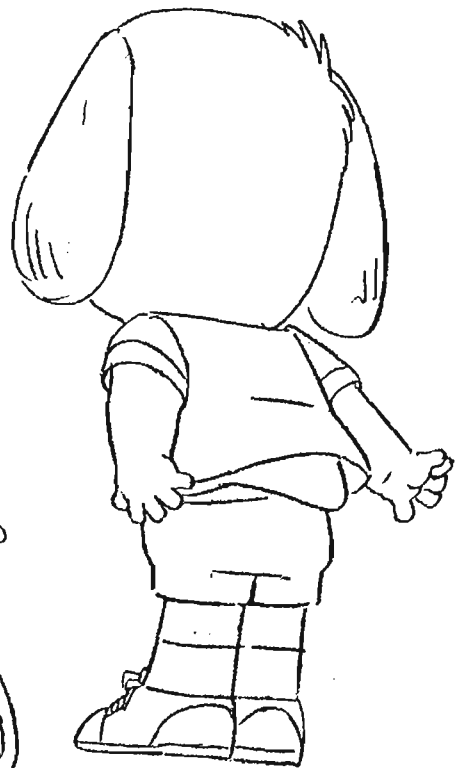
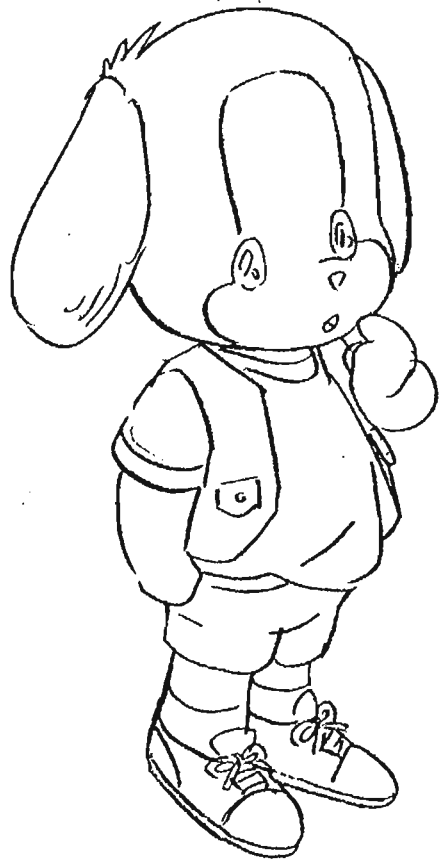

1957年 コッカー①

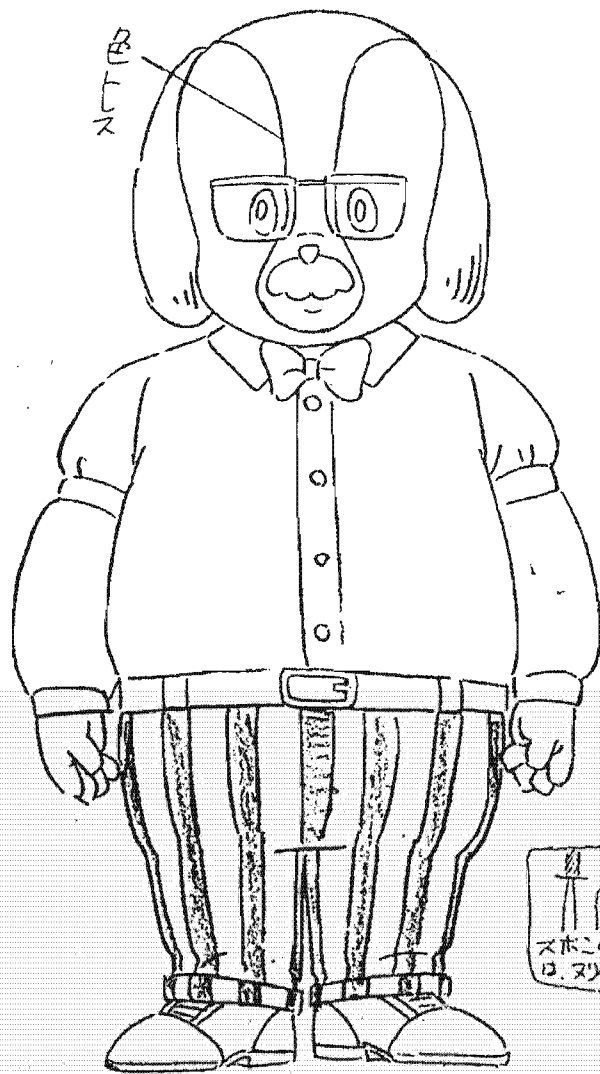

カトルス

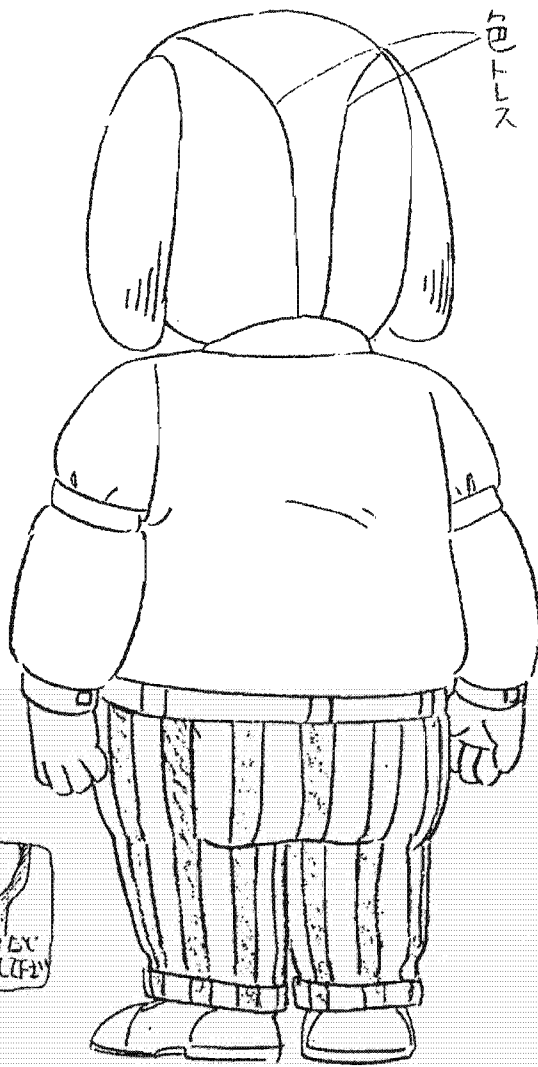

カトルス

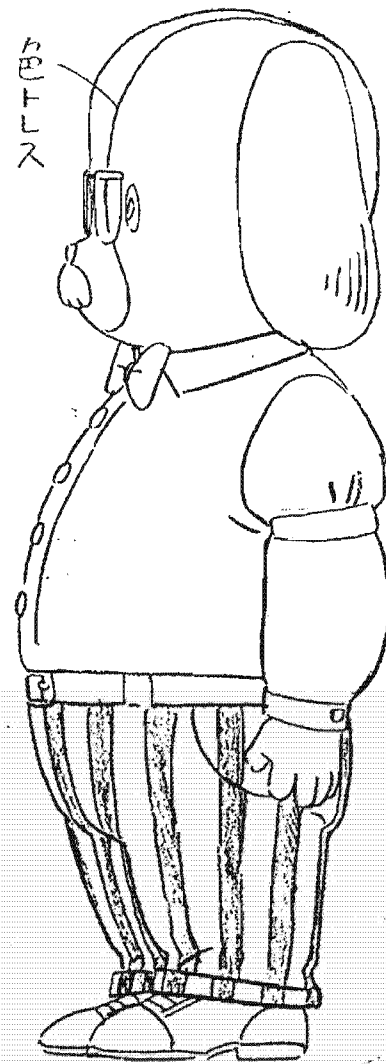

カトルス



ドラブラ ユッカー②



・超ロングの時日実線
・かぶりロングの時日色トレスのみ

タリア・コッカー①

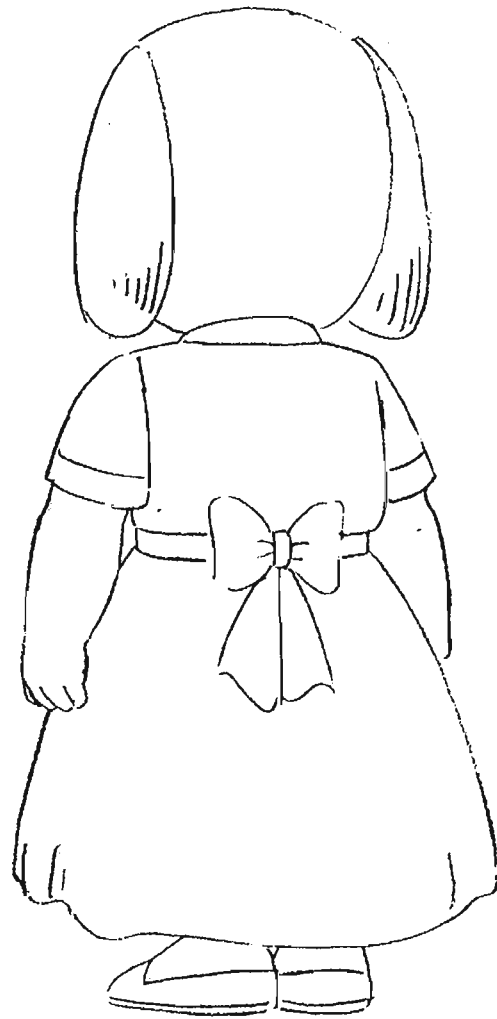
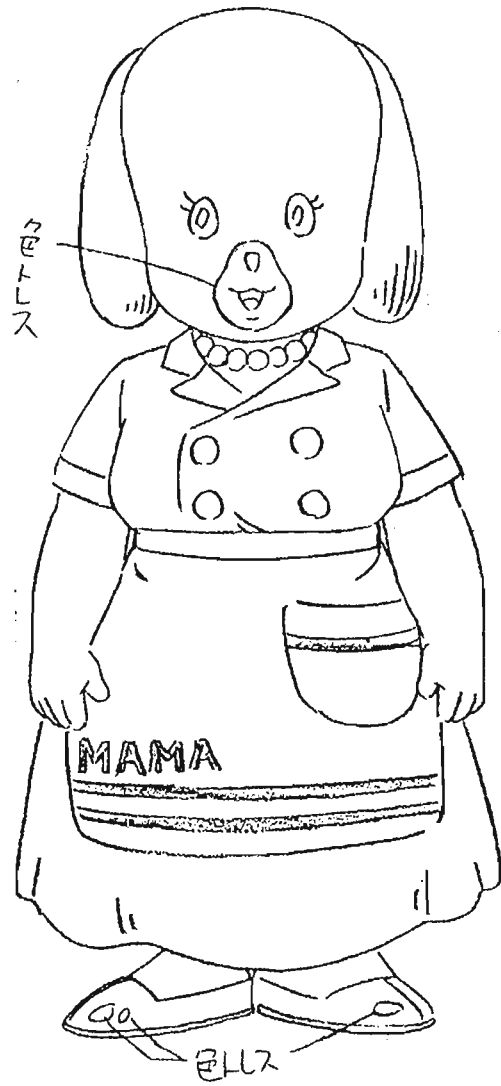

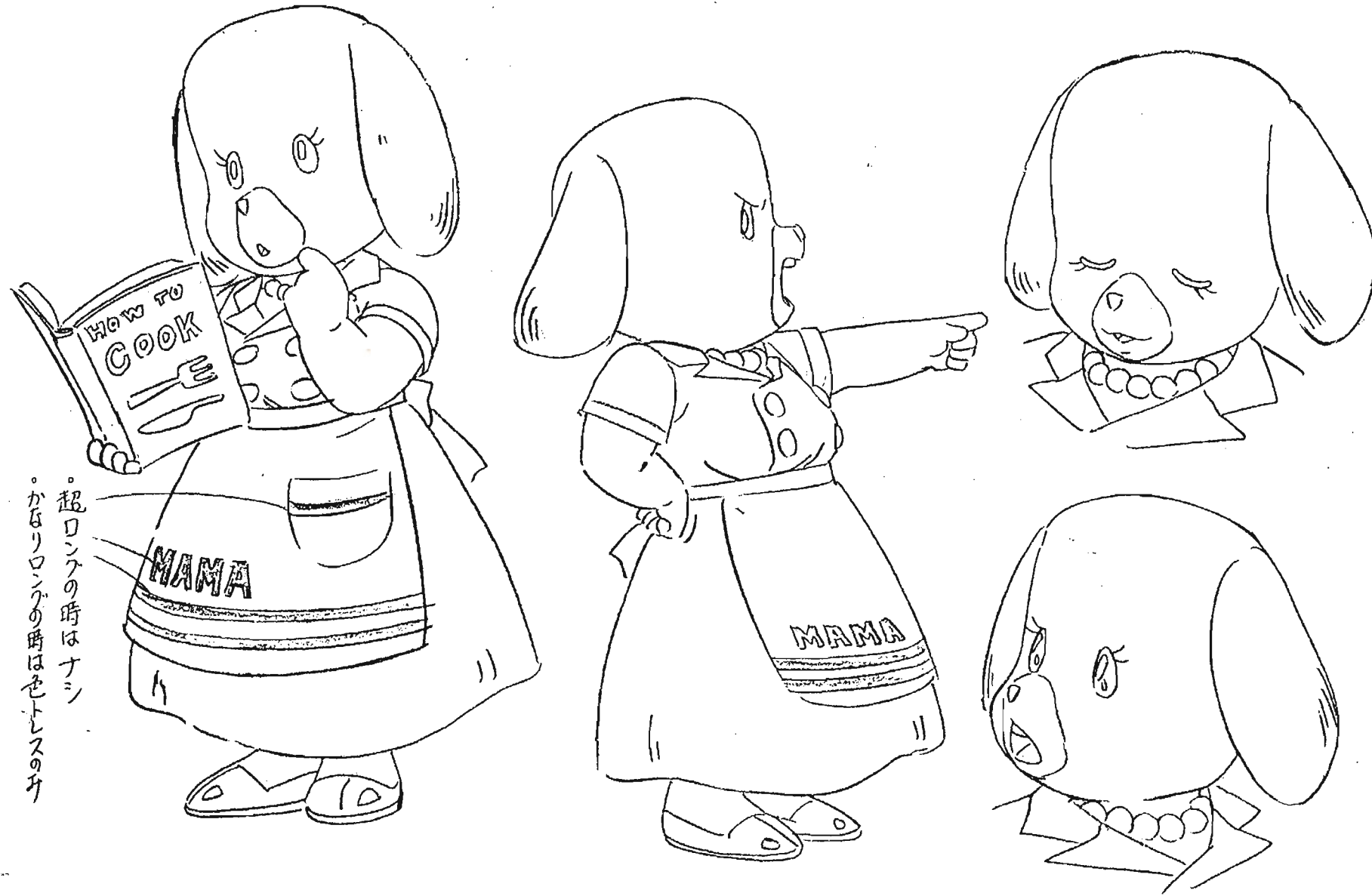

・超ロシアの時はナシ
・かなりロシアの時は色トレスのチ

ローリーの家庭教師 ①

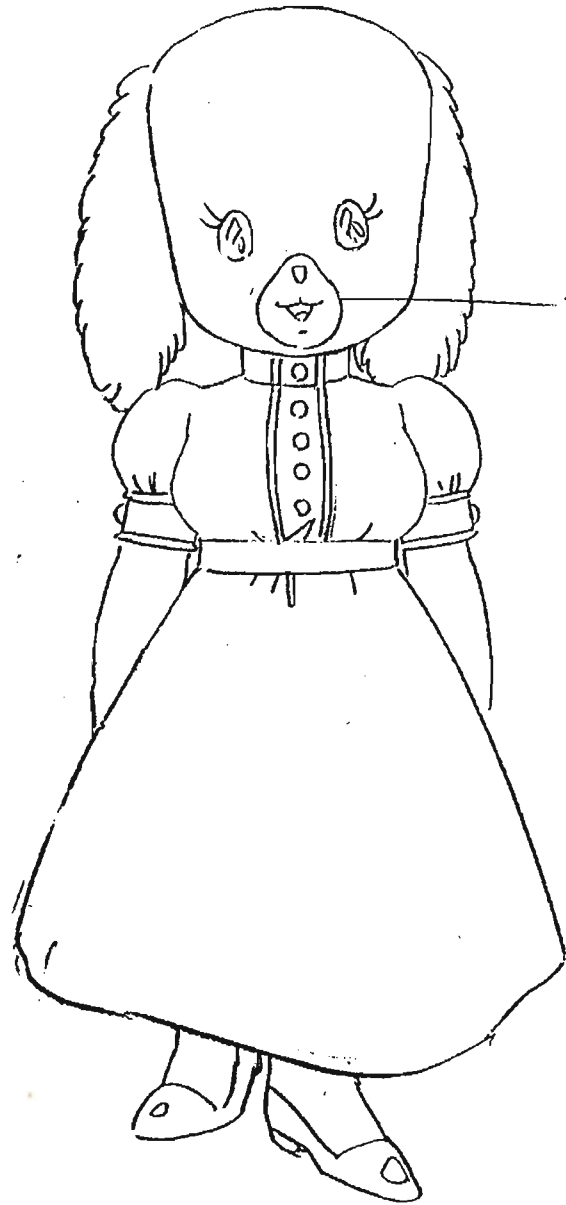

色①

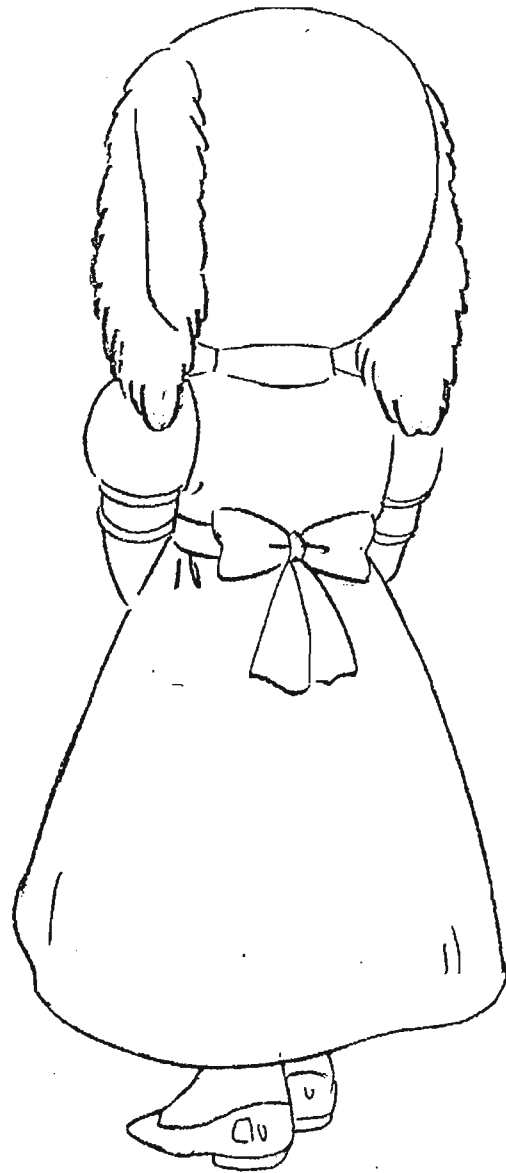
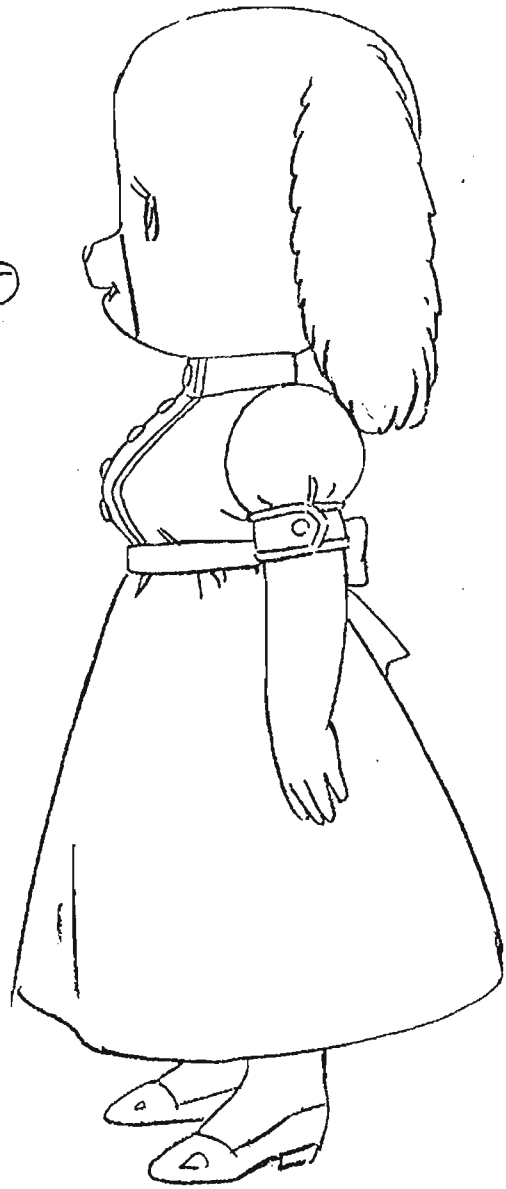

ドーリアの生徒教師①

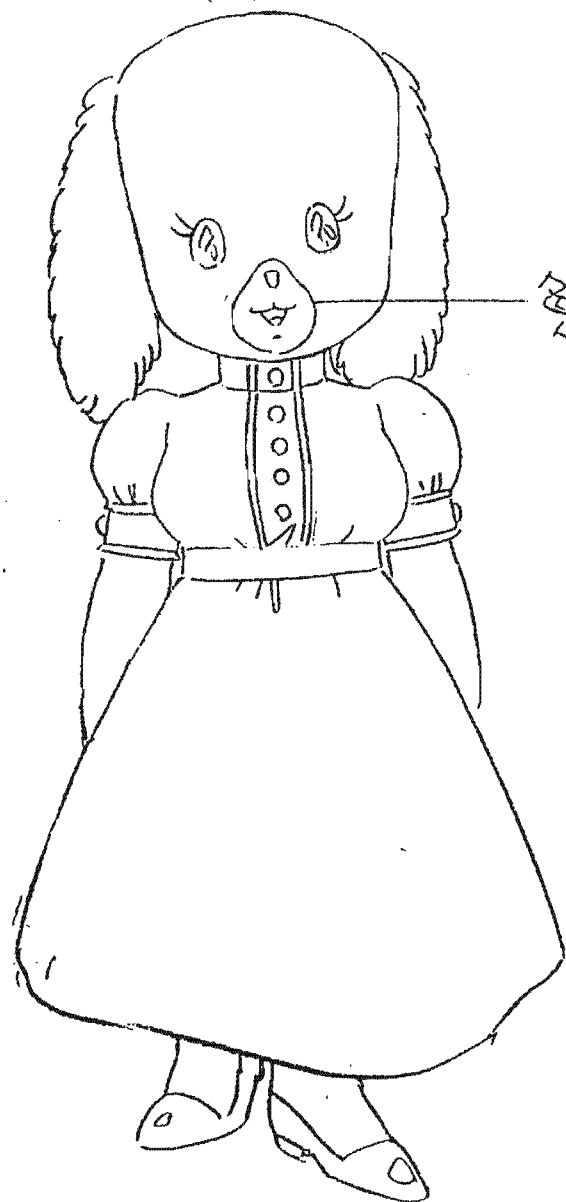

ア
ル
ル

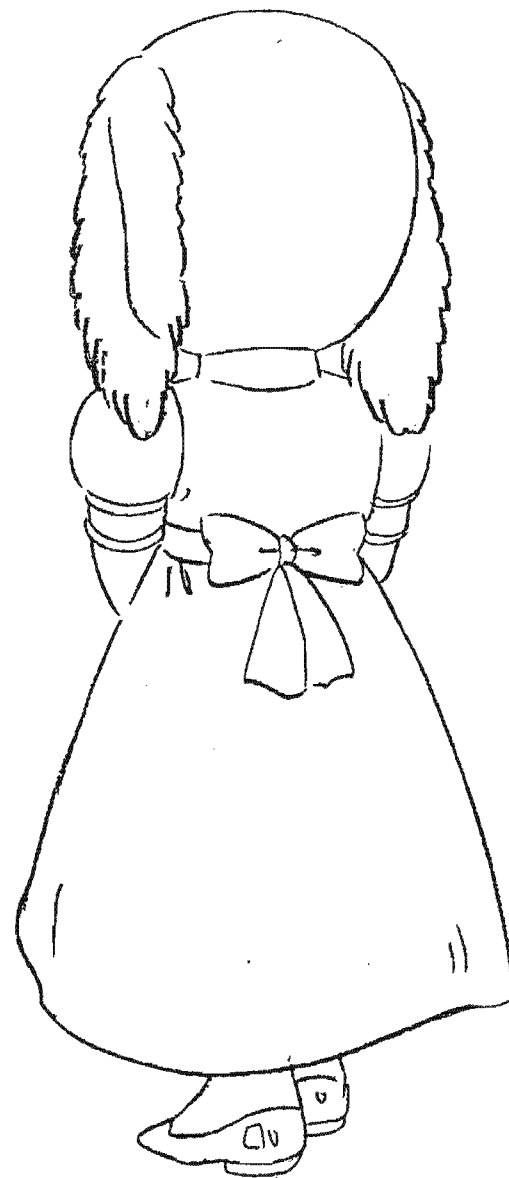
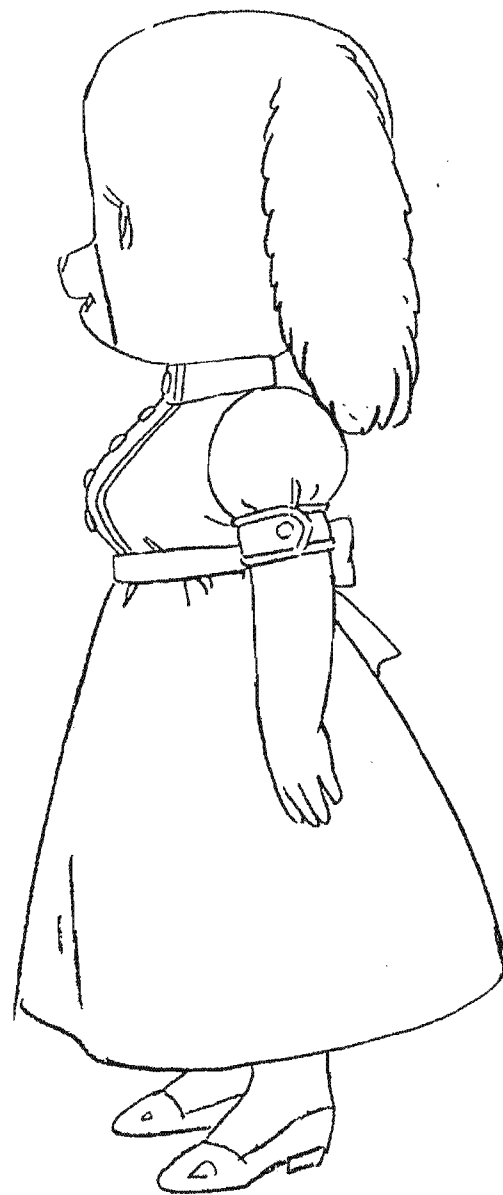

12-15の元庭教師②

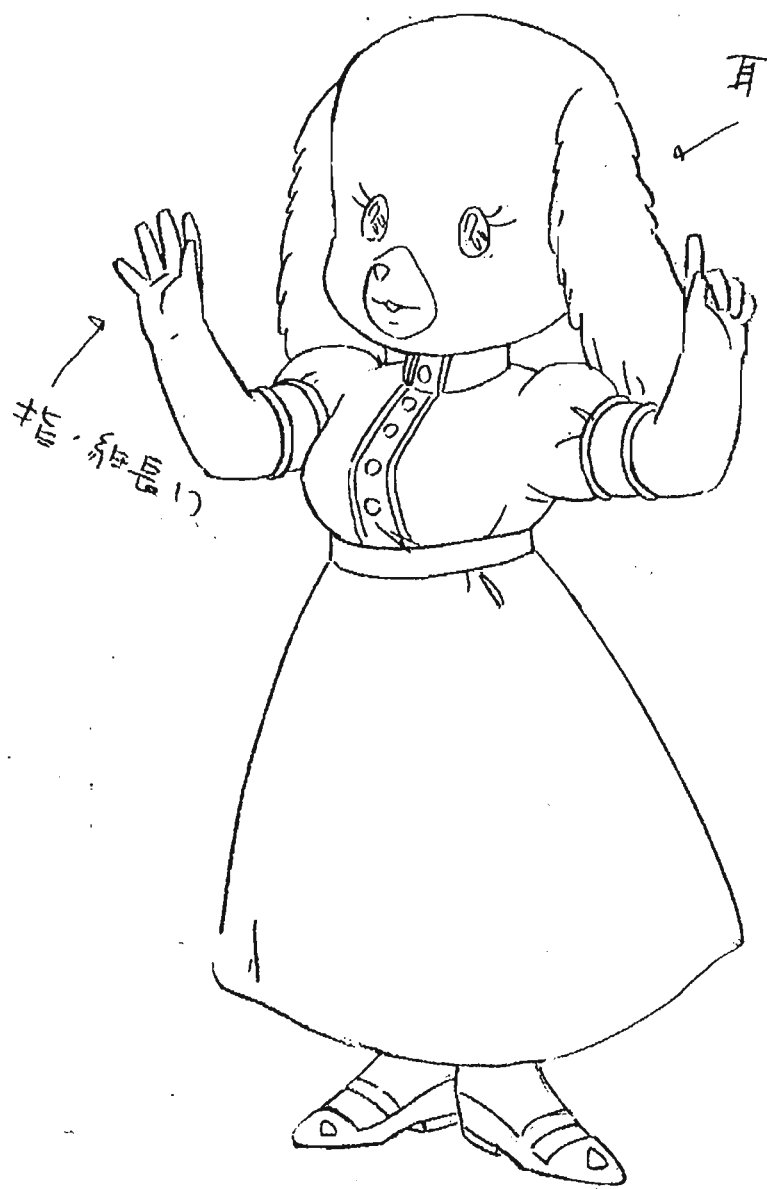

パーティホーラビット ①
～看護服～

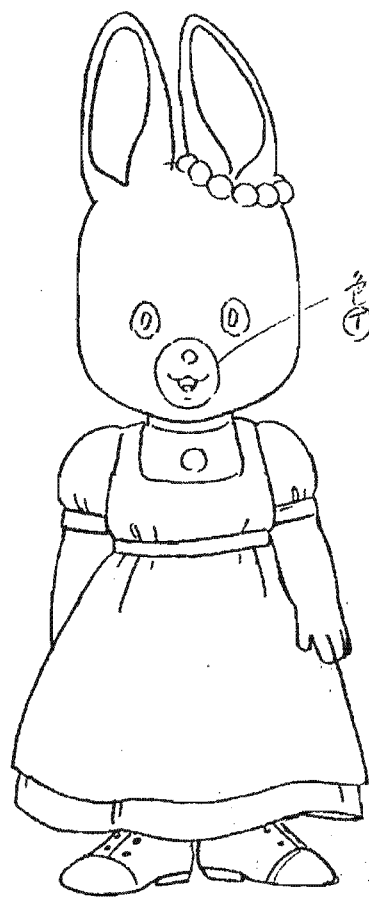

①

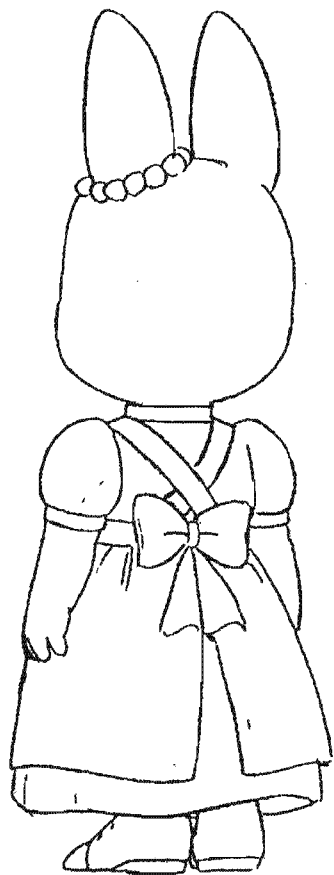

②

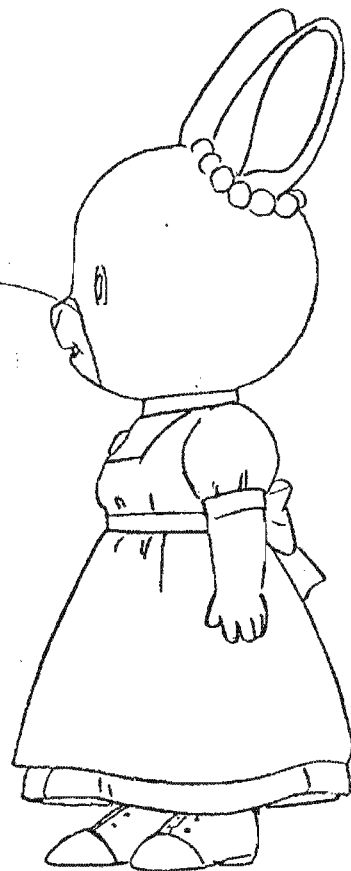

パーティ 3.木ん着 ②A

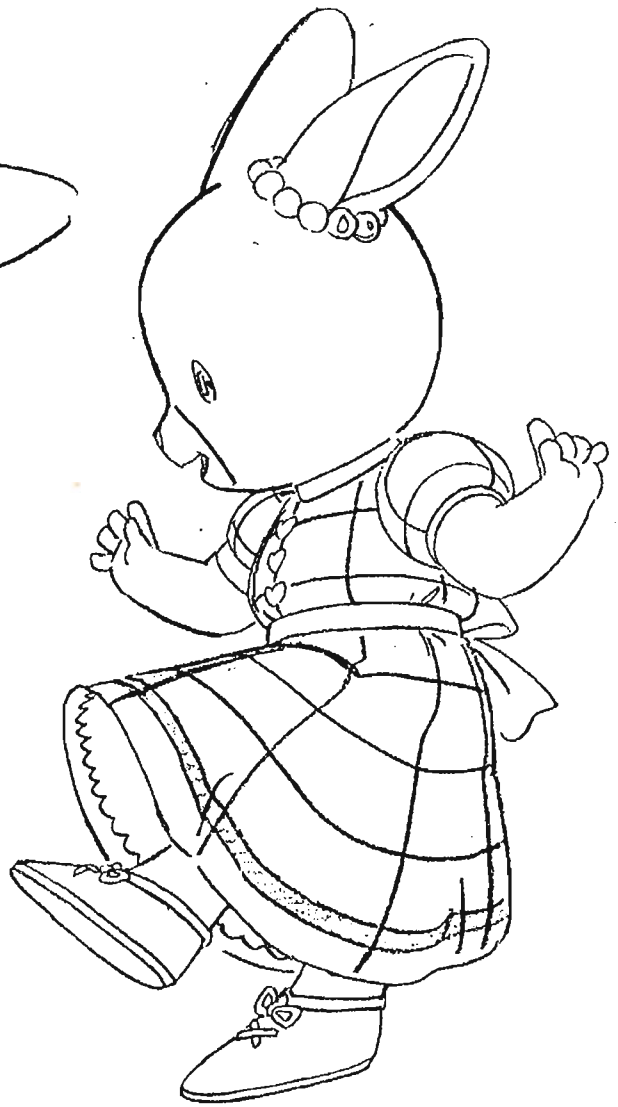
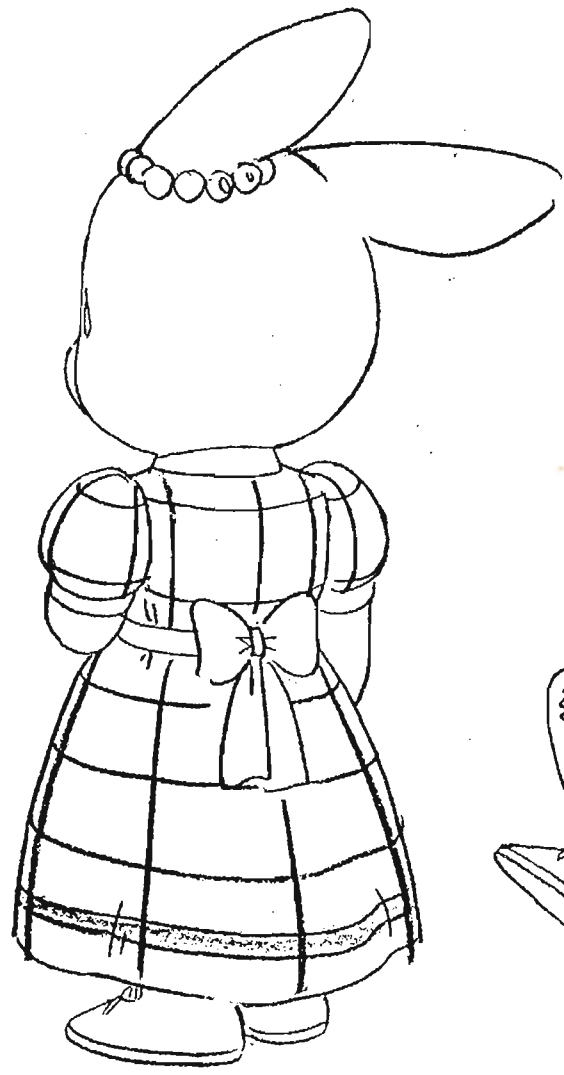
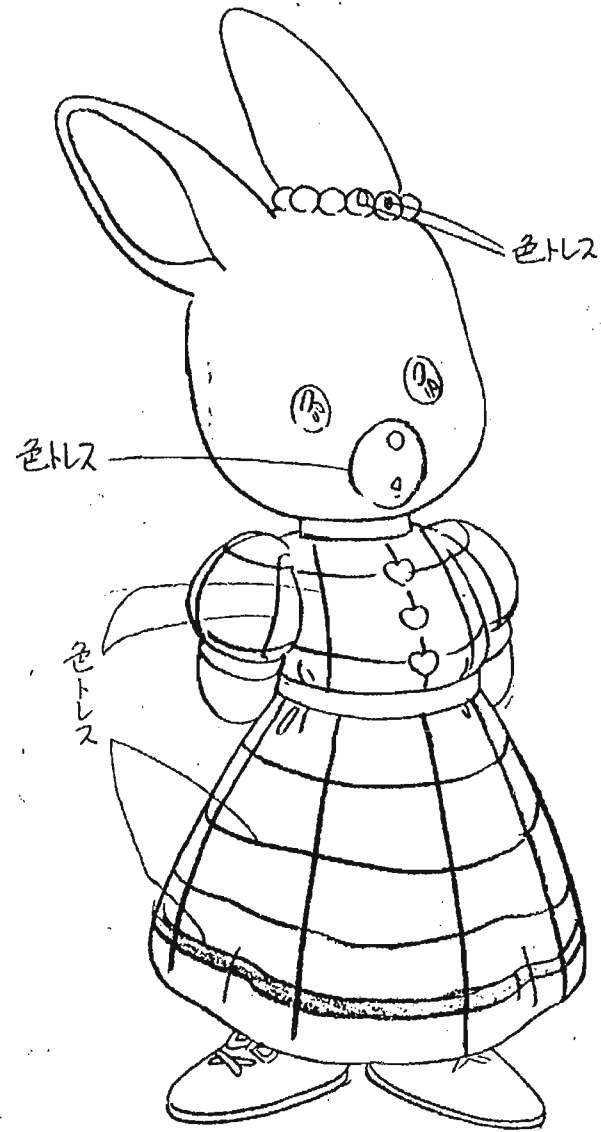

パーティ ふたし着 ② B

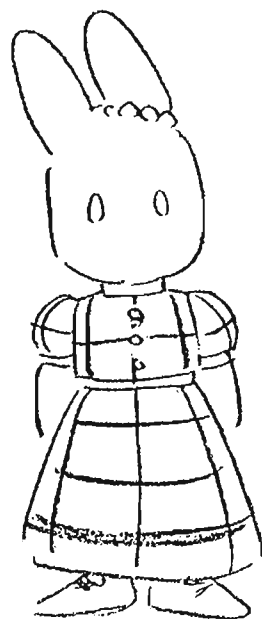
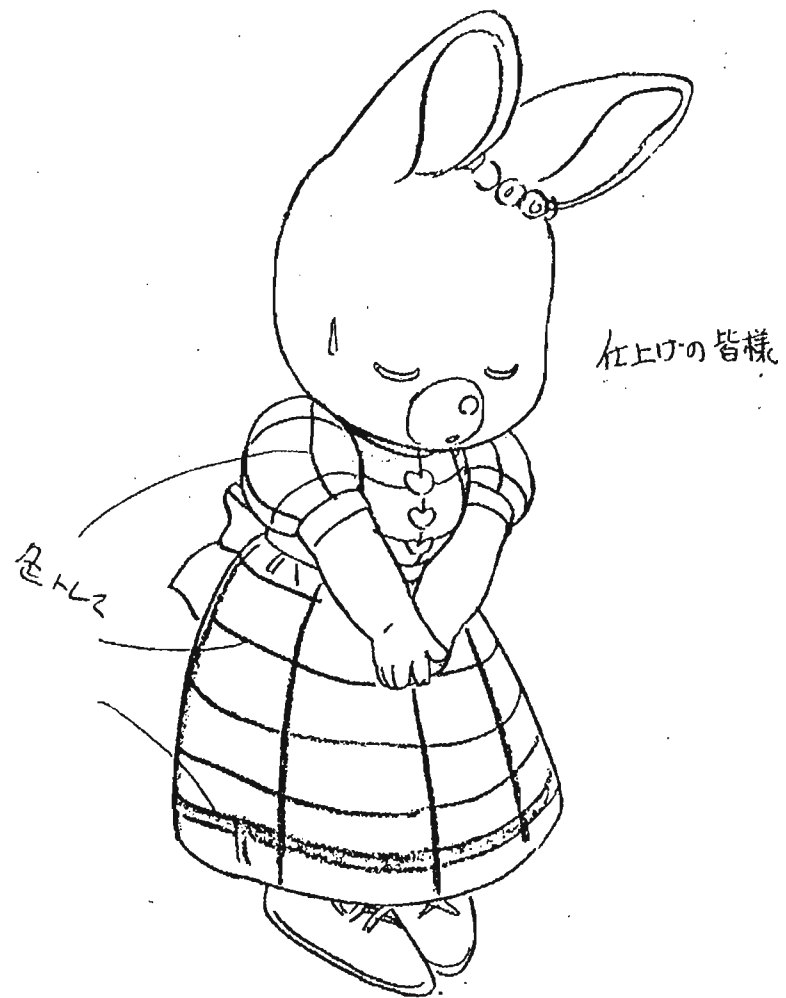

ロングの場合
色トレスへらす

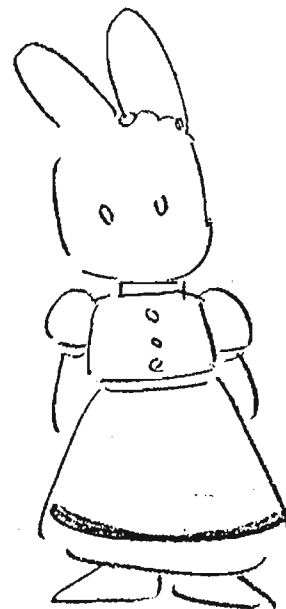

超ロングの場合
細い色トレスの後は
省略する

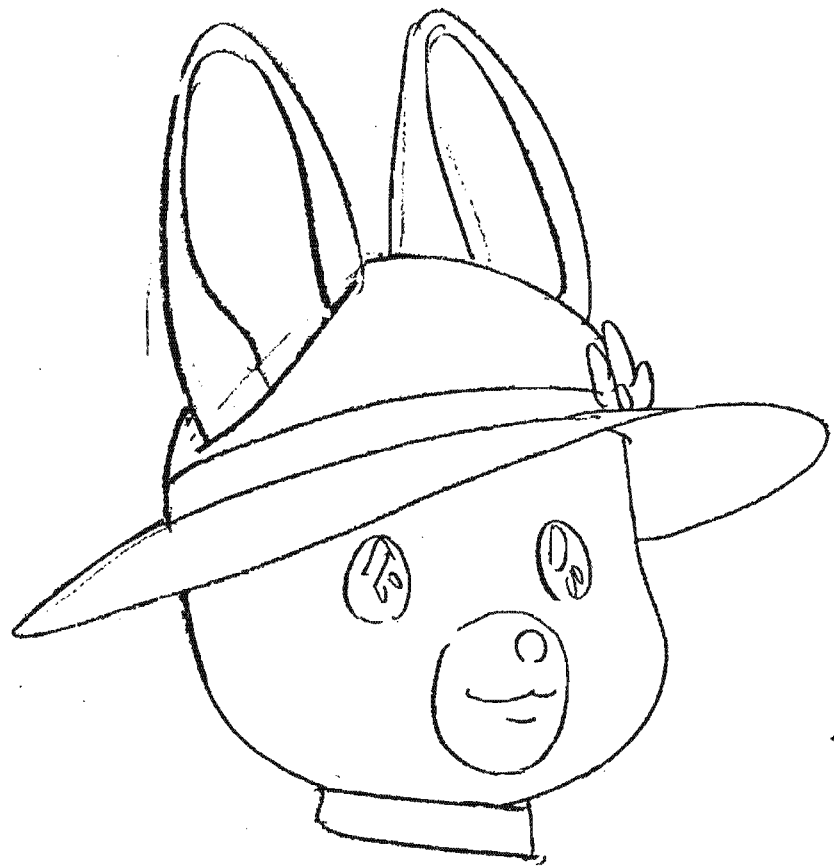

パテムの 帽子

メイプルタウン物語
南の国のパームタウン

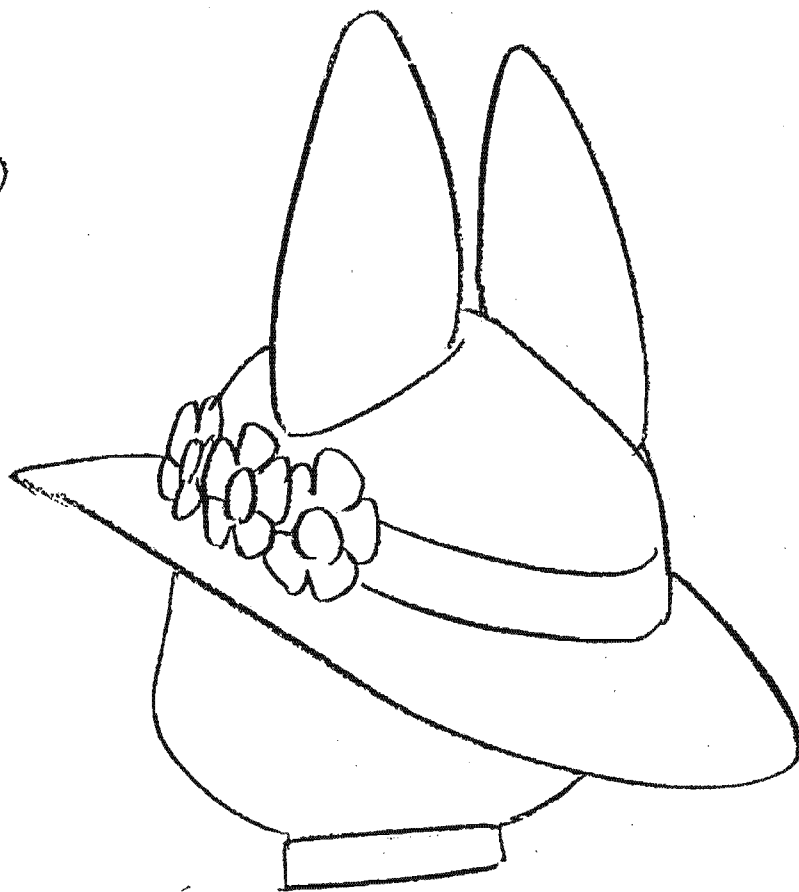

11074. ホ-705ビ-ト ⑤

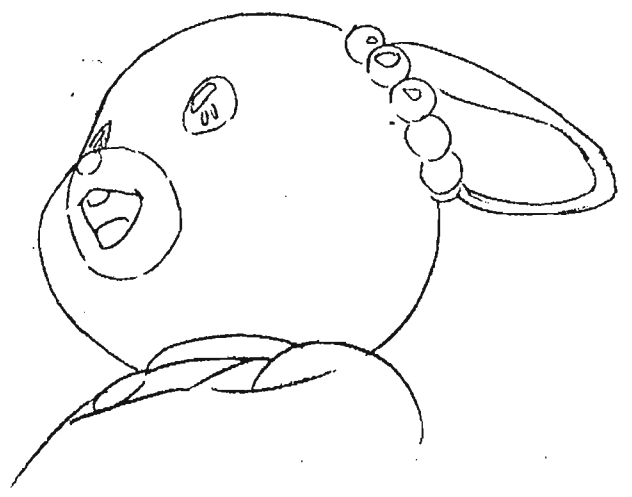
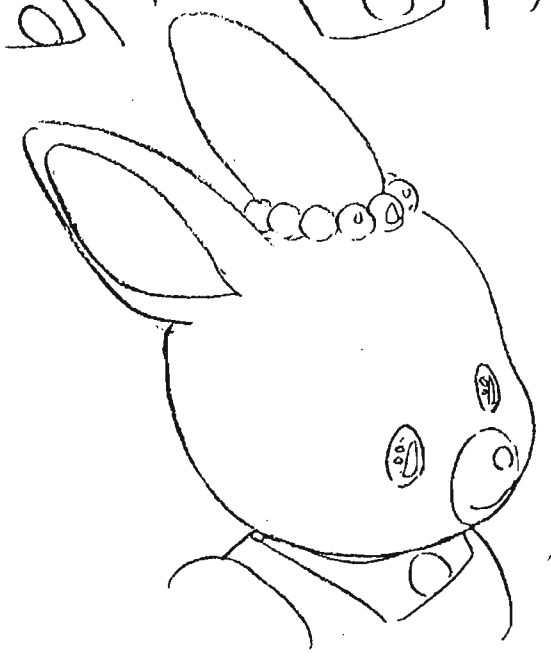
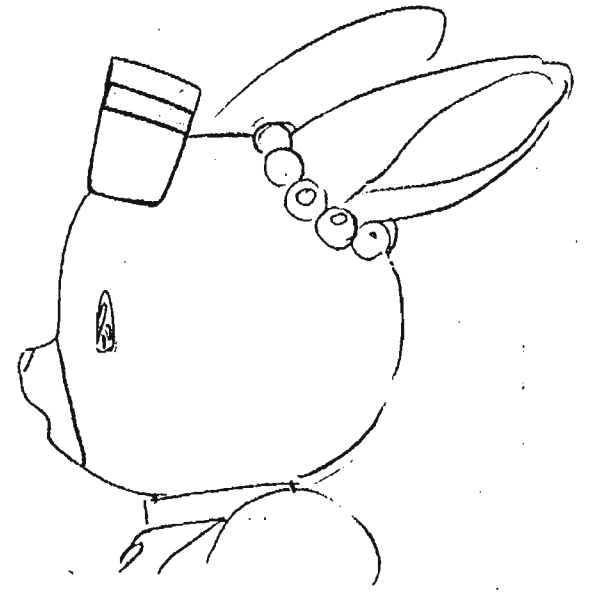
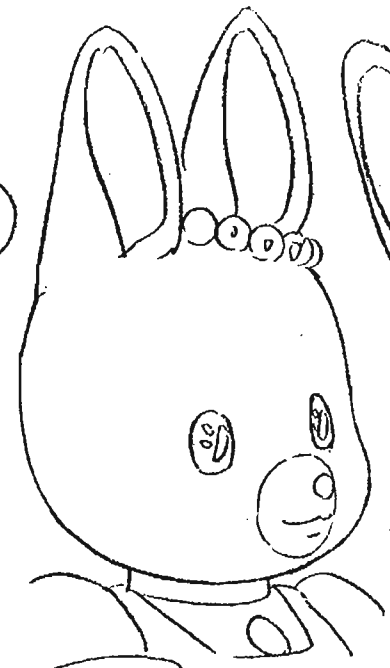

パティの通学バスケット

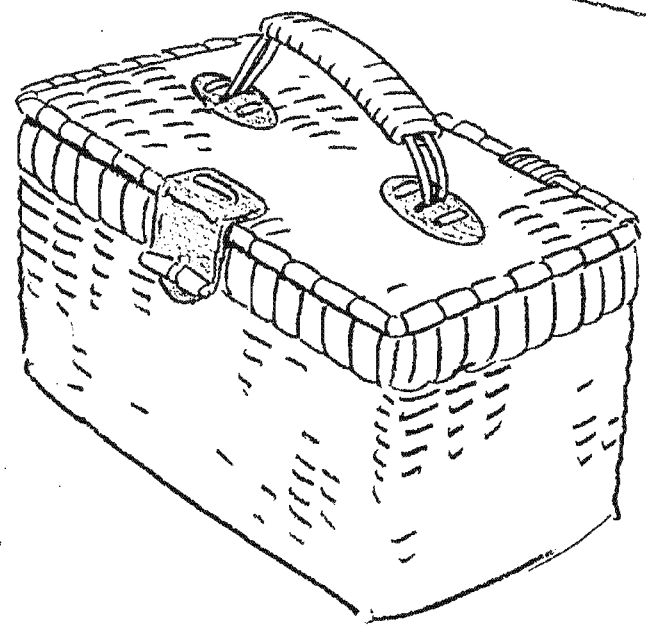

少し大き
ローリーのランチボックスより
本が入っているのだ

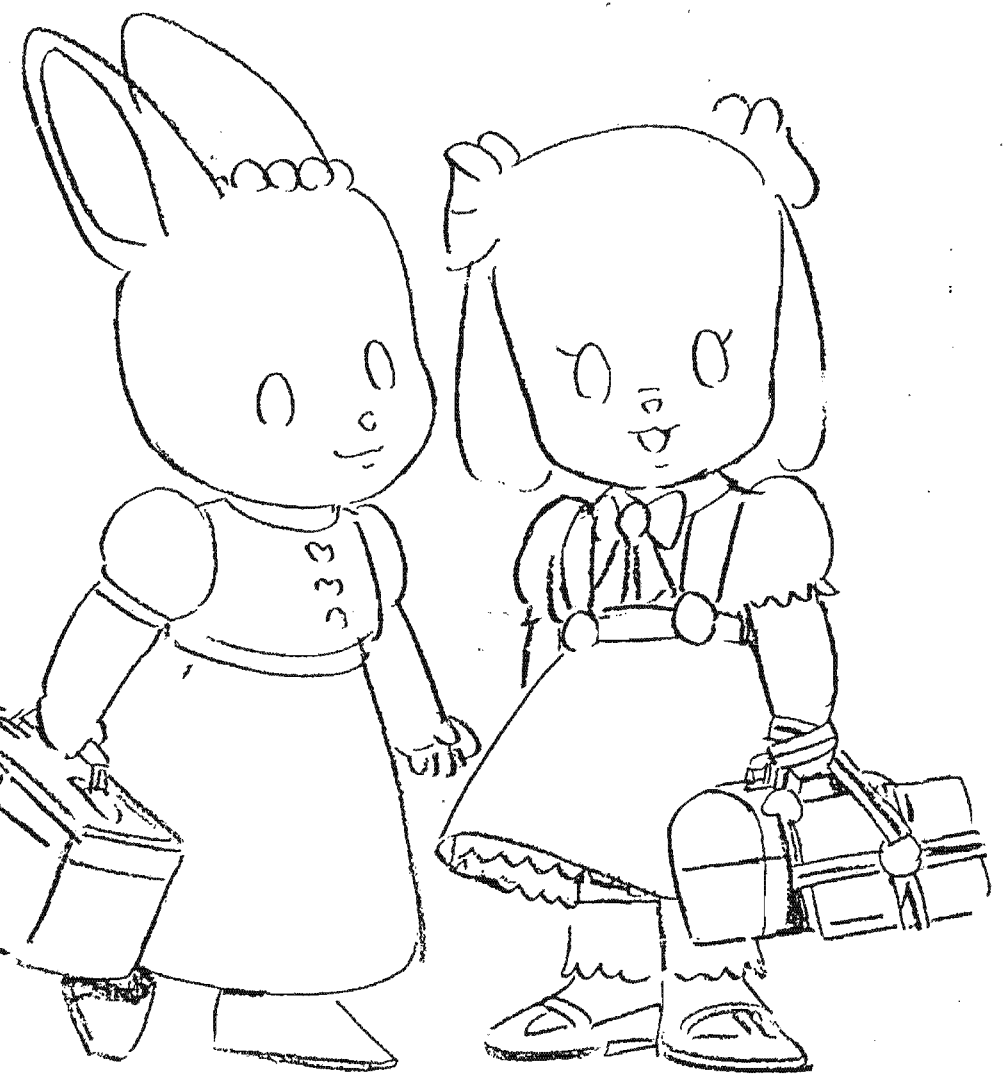

メイプルタウン物語
南の国のパームタウン

11/27 2014

皮

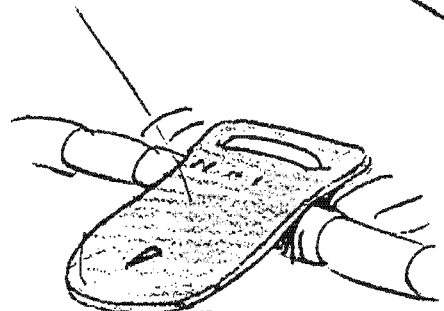

木

皮

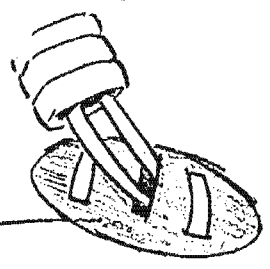

ショ-シ-119カ ①

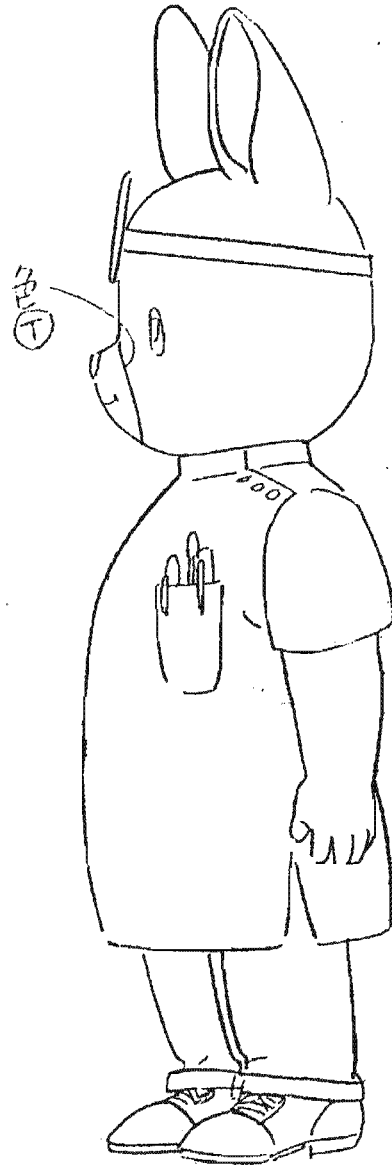
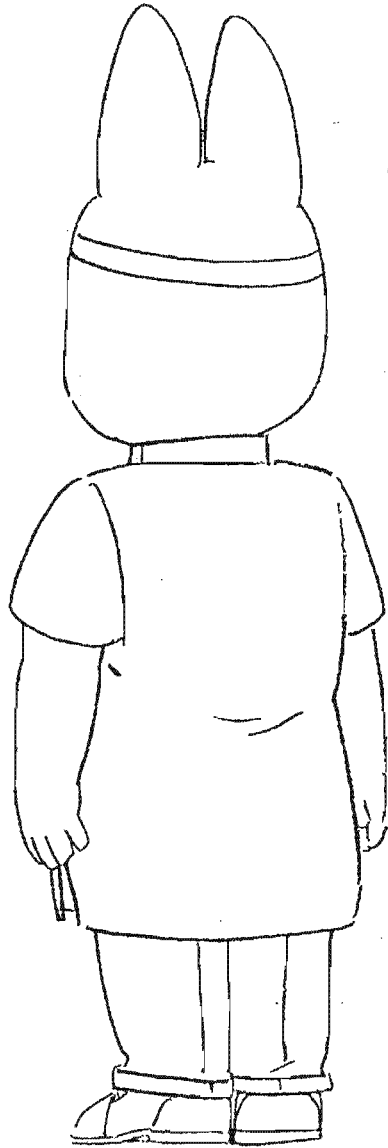
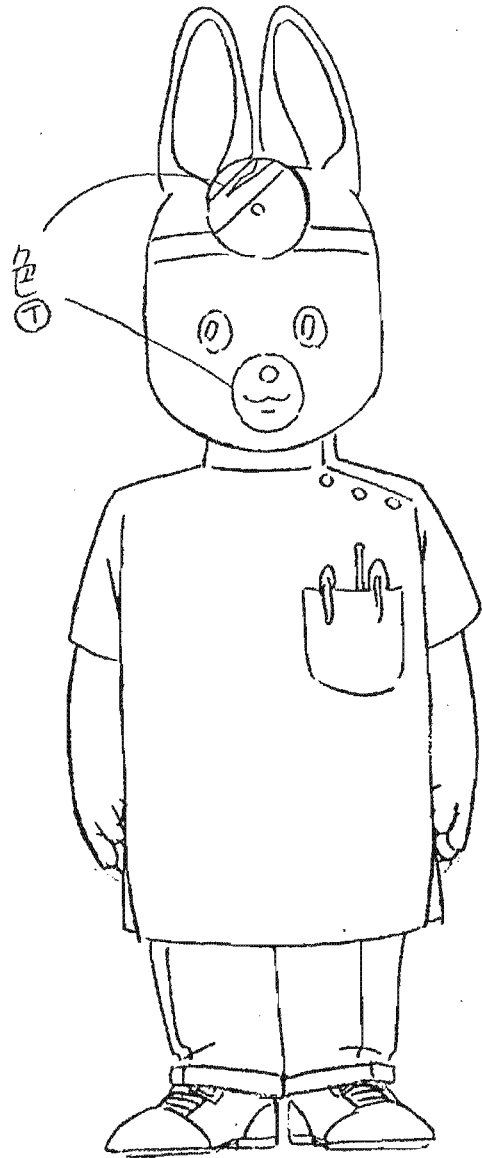

エコーエコー11月カ②

11/26 22

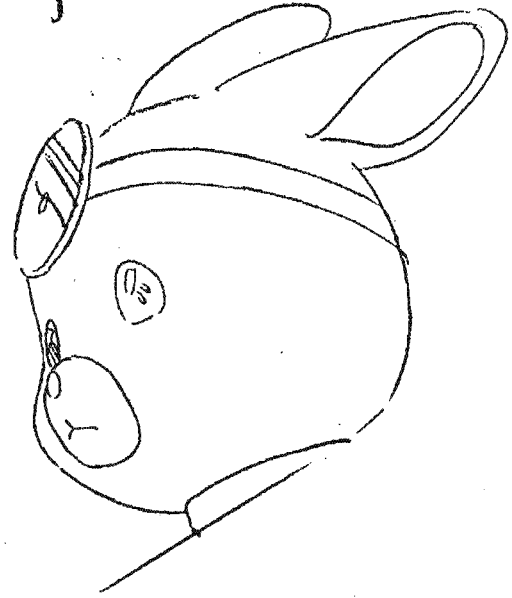
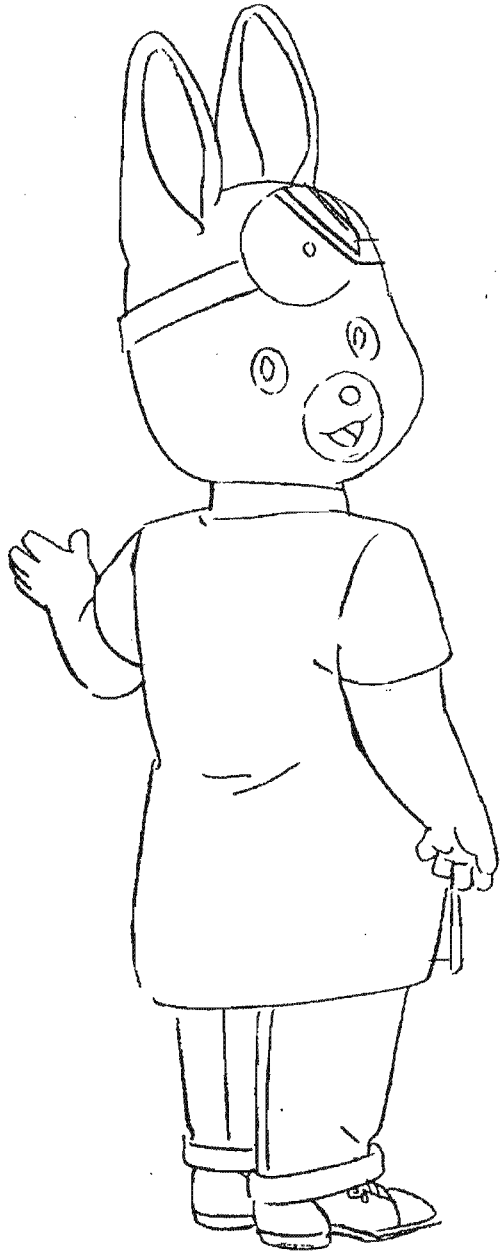

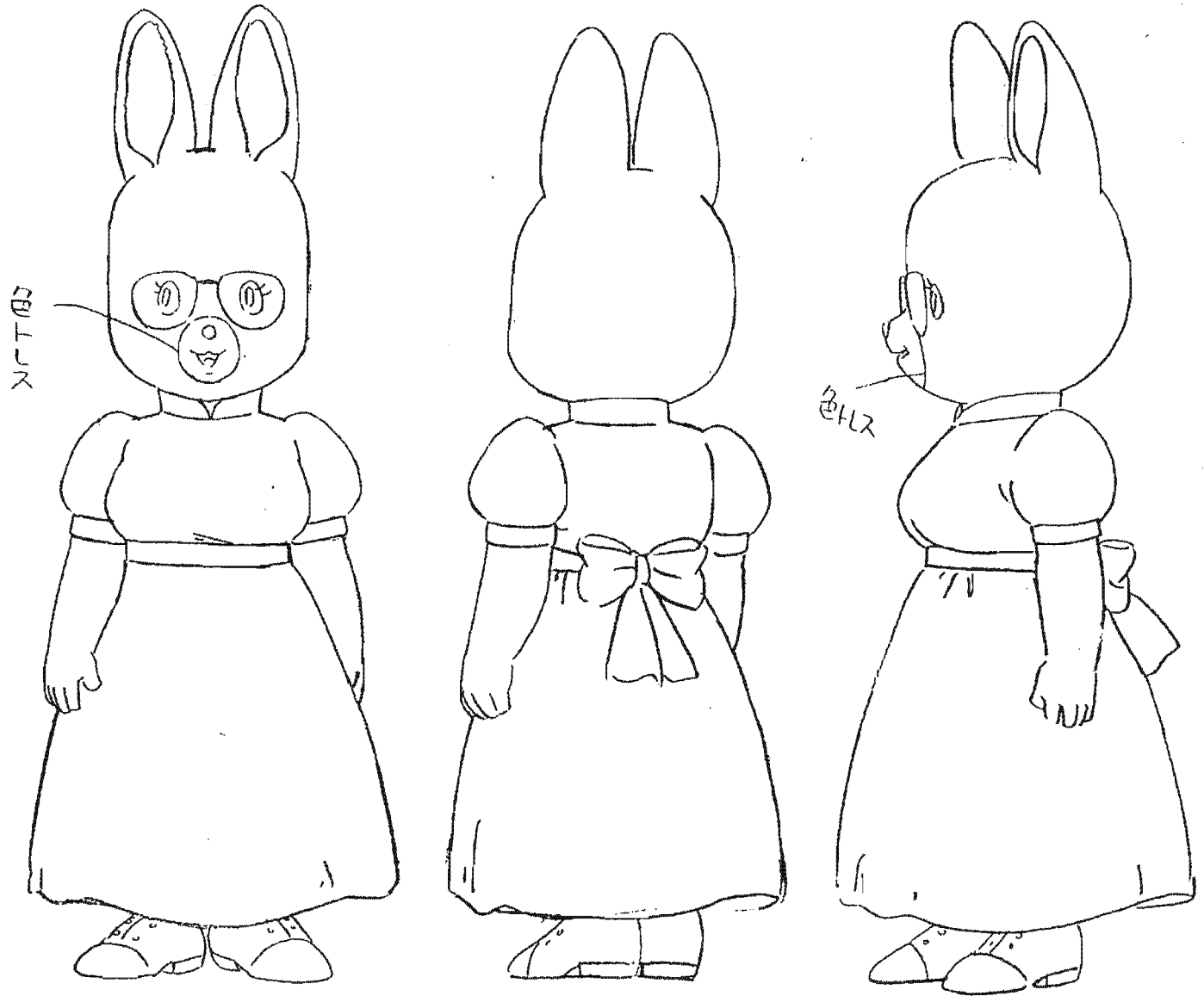

シェン パイカ ②

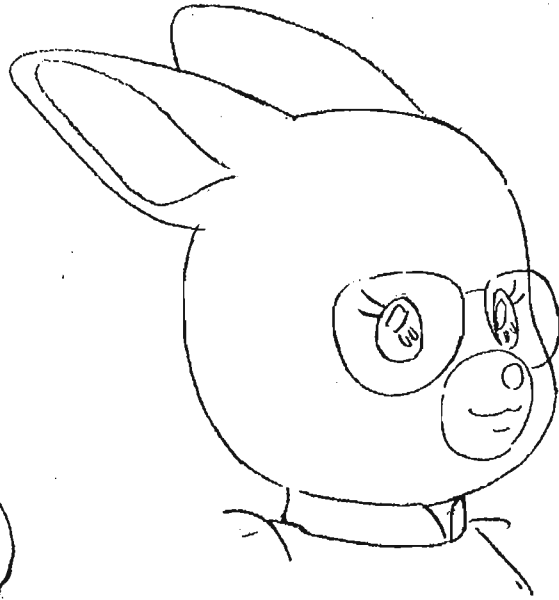

ジュニアハイカ ③
— 旅行服 —

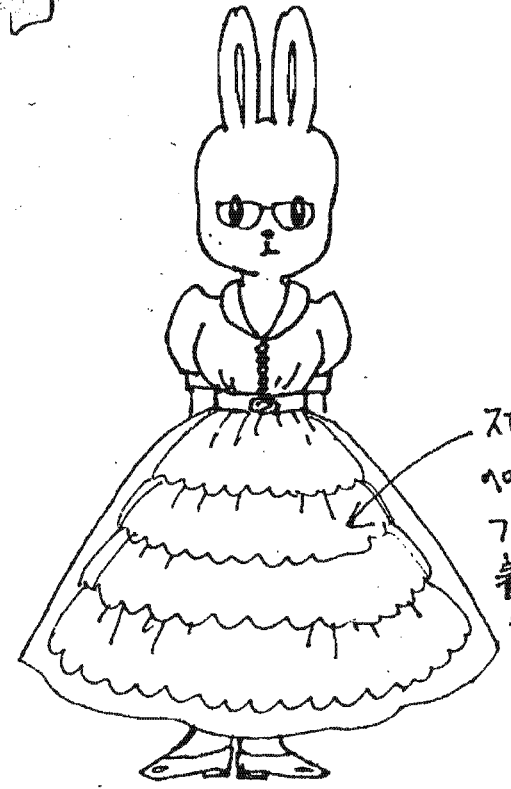
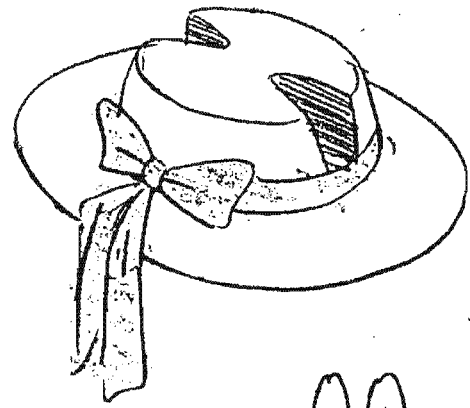
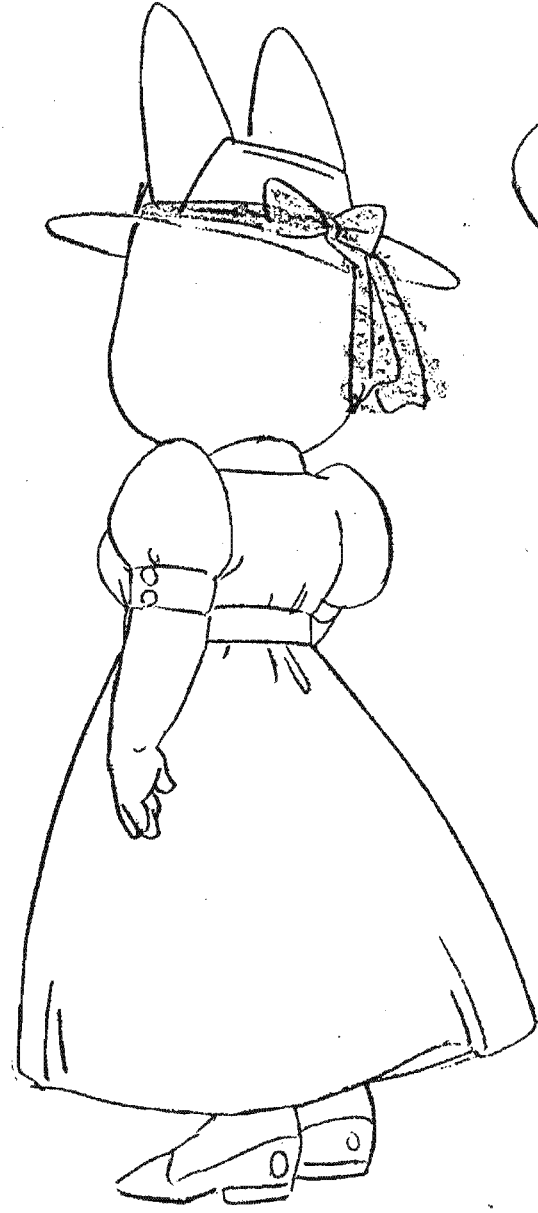

スカートの中味
ハココート
フランス人形が
着てるみたいな
ものです。

看護婦ブーツ

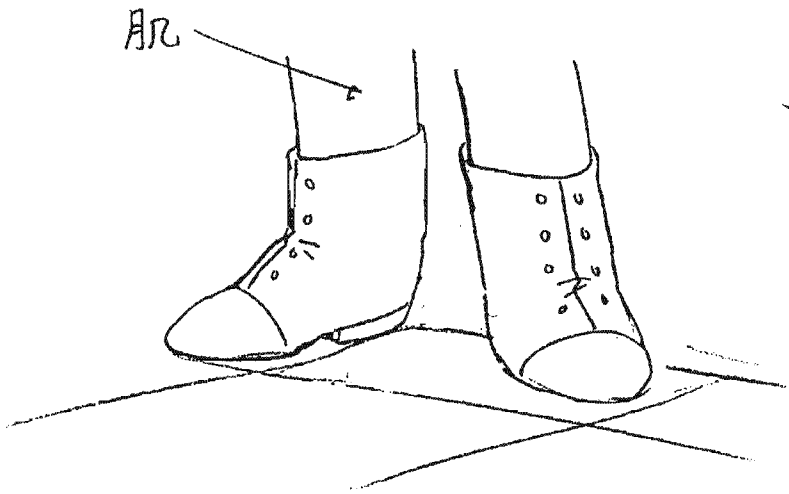

アリスのみ
ソックス
はいています

アリス①

ロシケの時々
包トスる

ノミル
92目

①

②

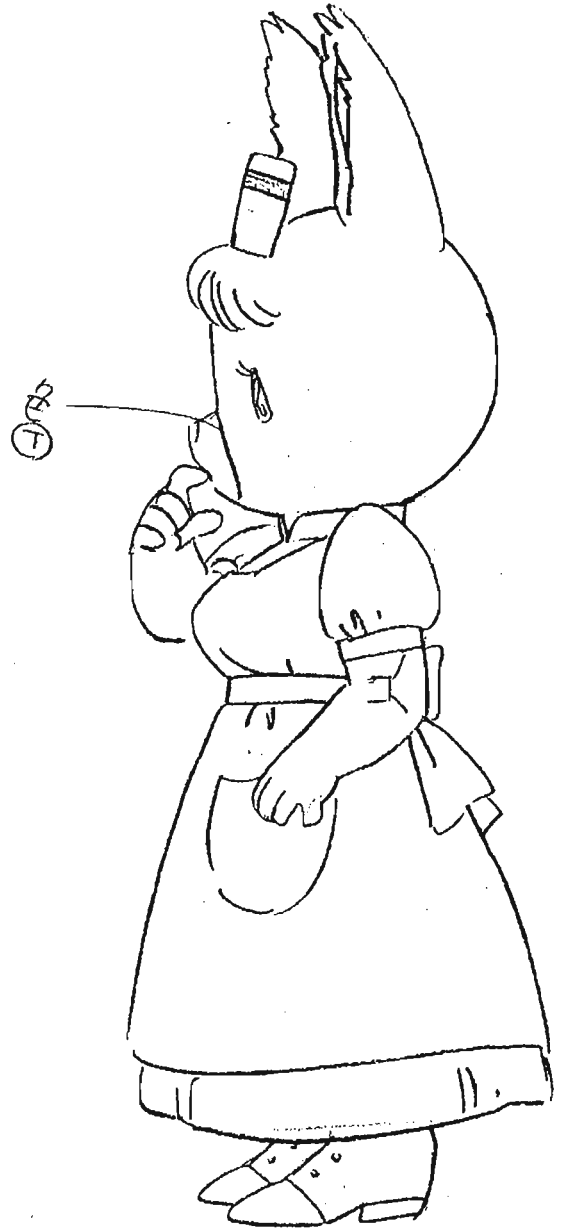
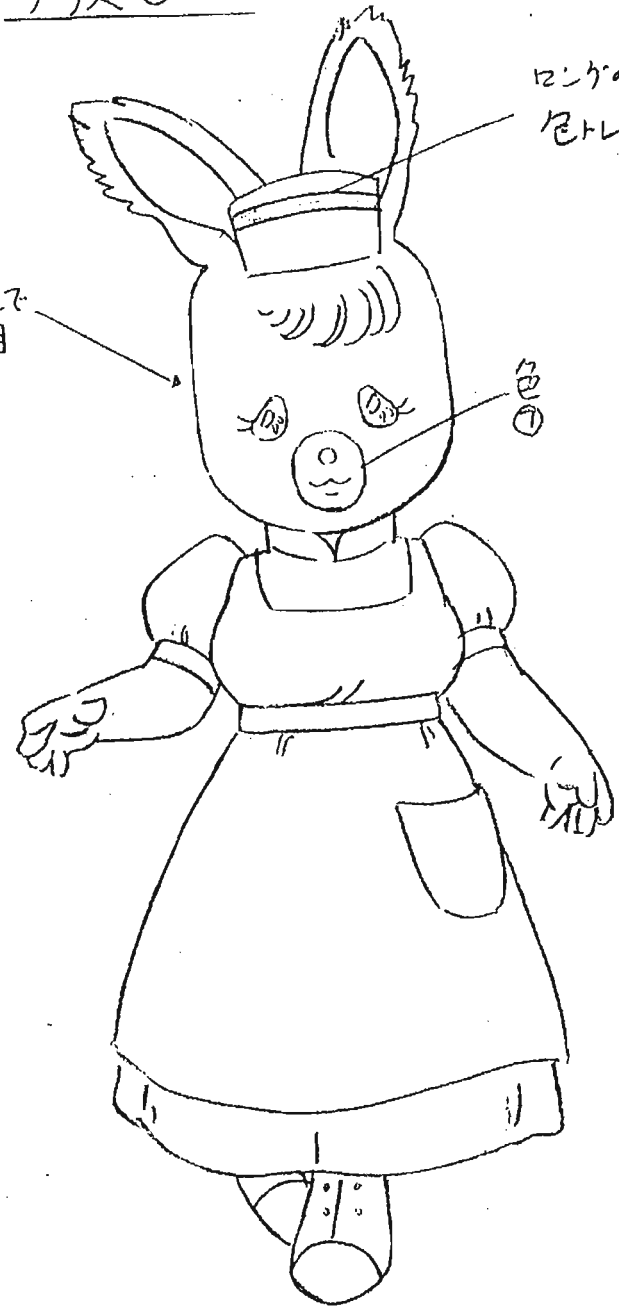

アリス②

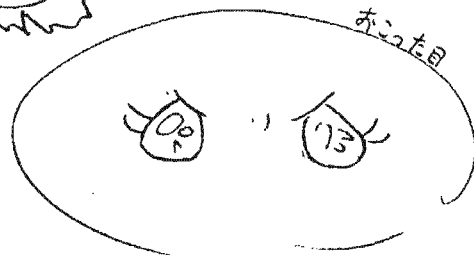
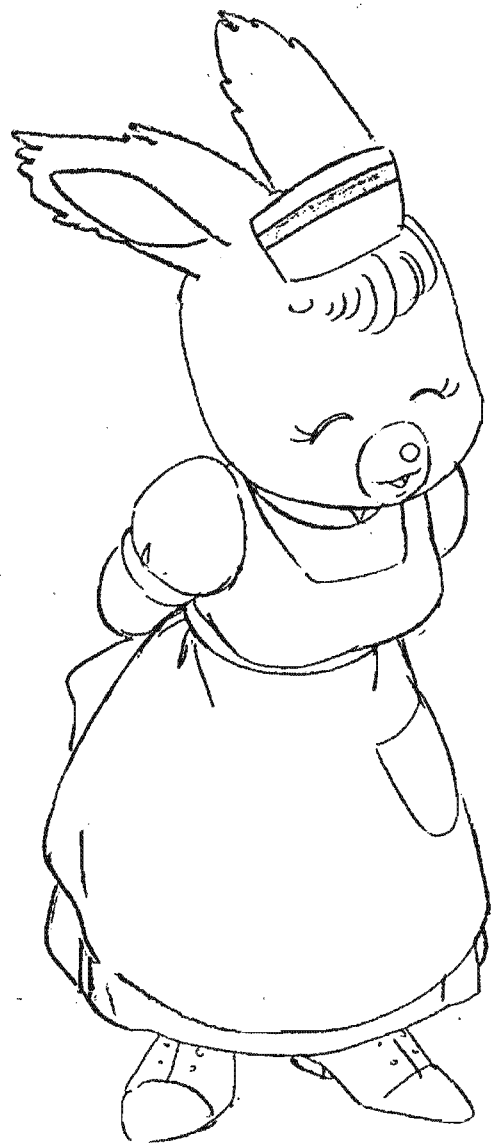

テリヤファミリー

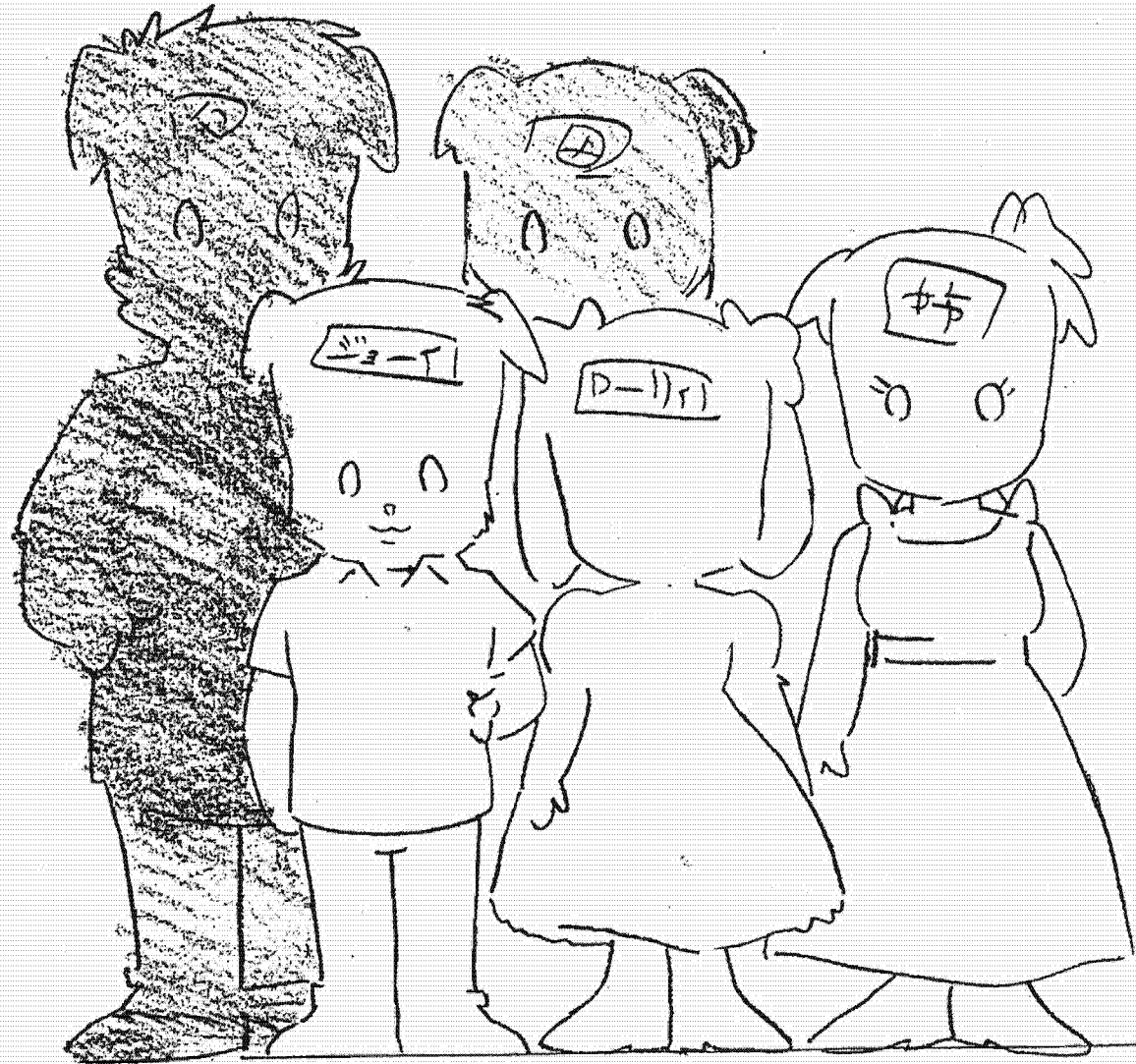

ニョーイ・テリヤ①

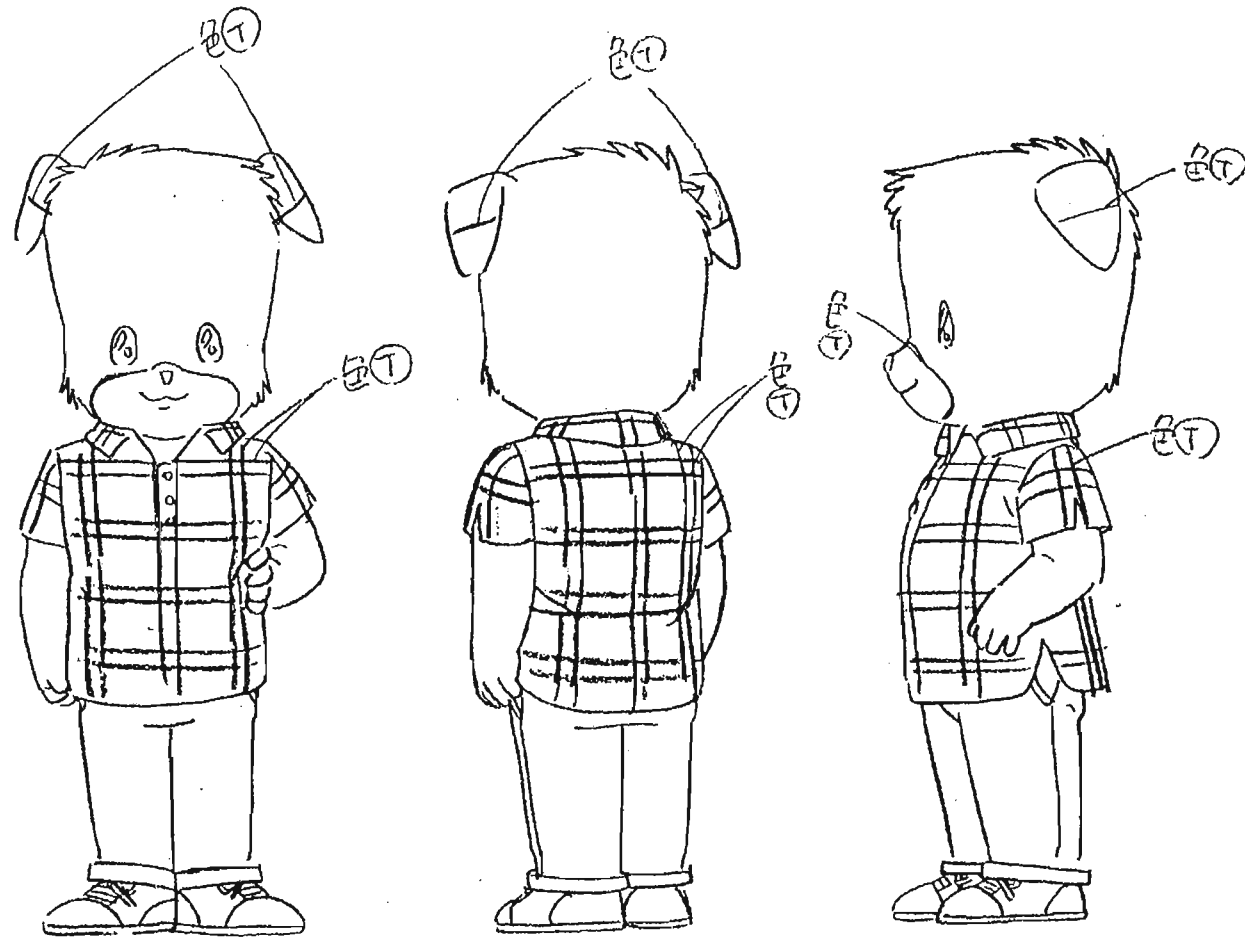

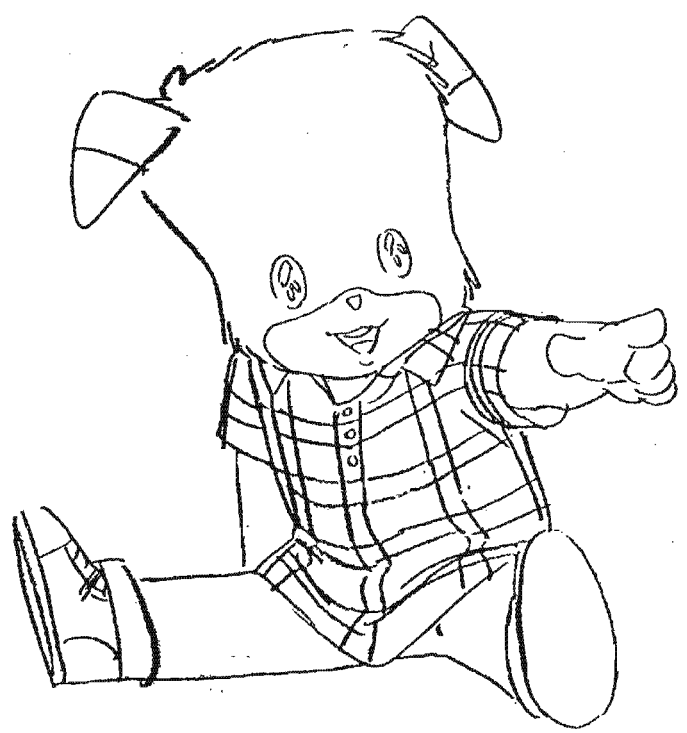

ミョーイ・テリヤ③

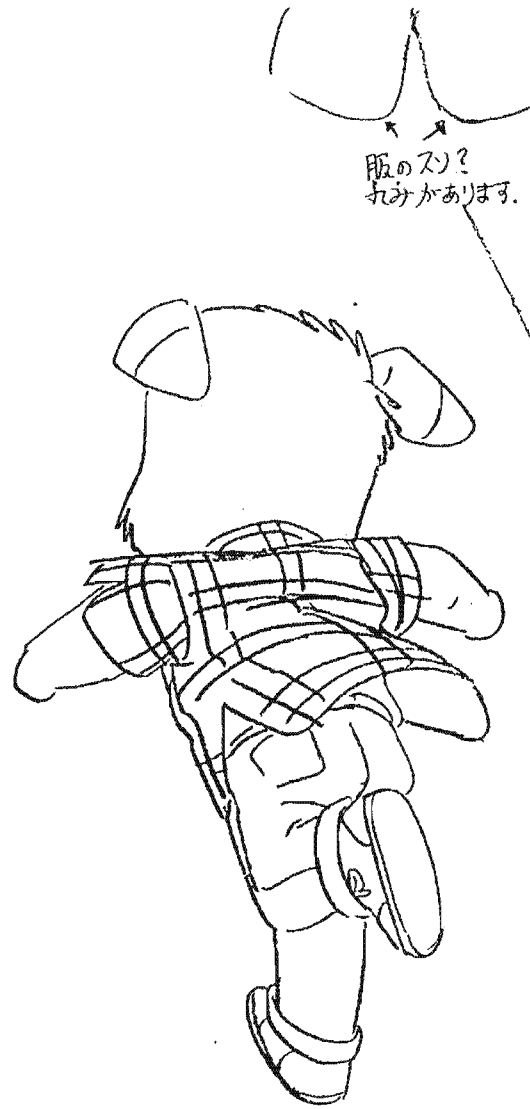

ロンクの際は普通の
イエロー柄

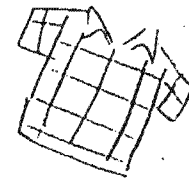

三三-イ・テリア④

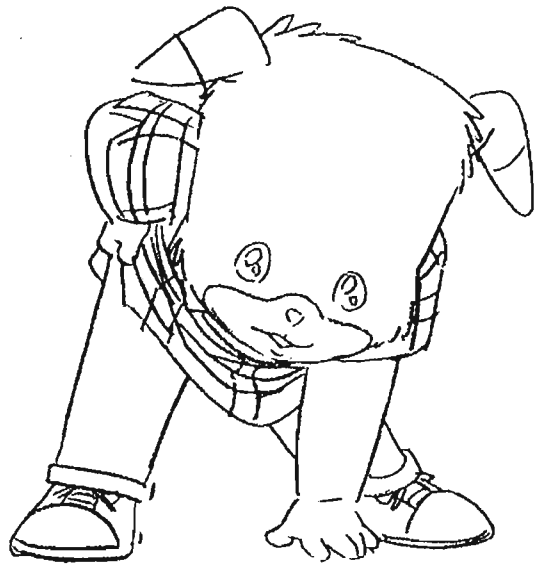

ショーイテリヤ⑤

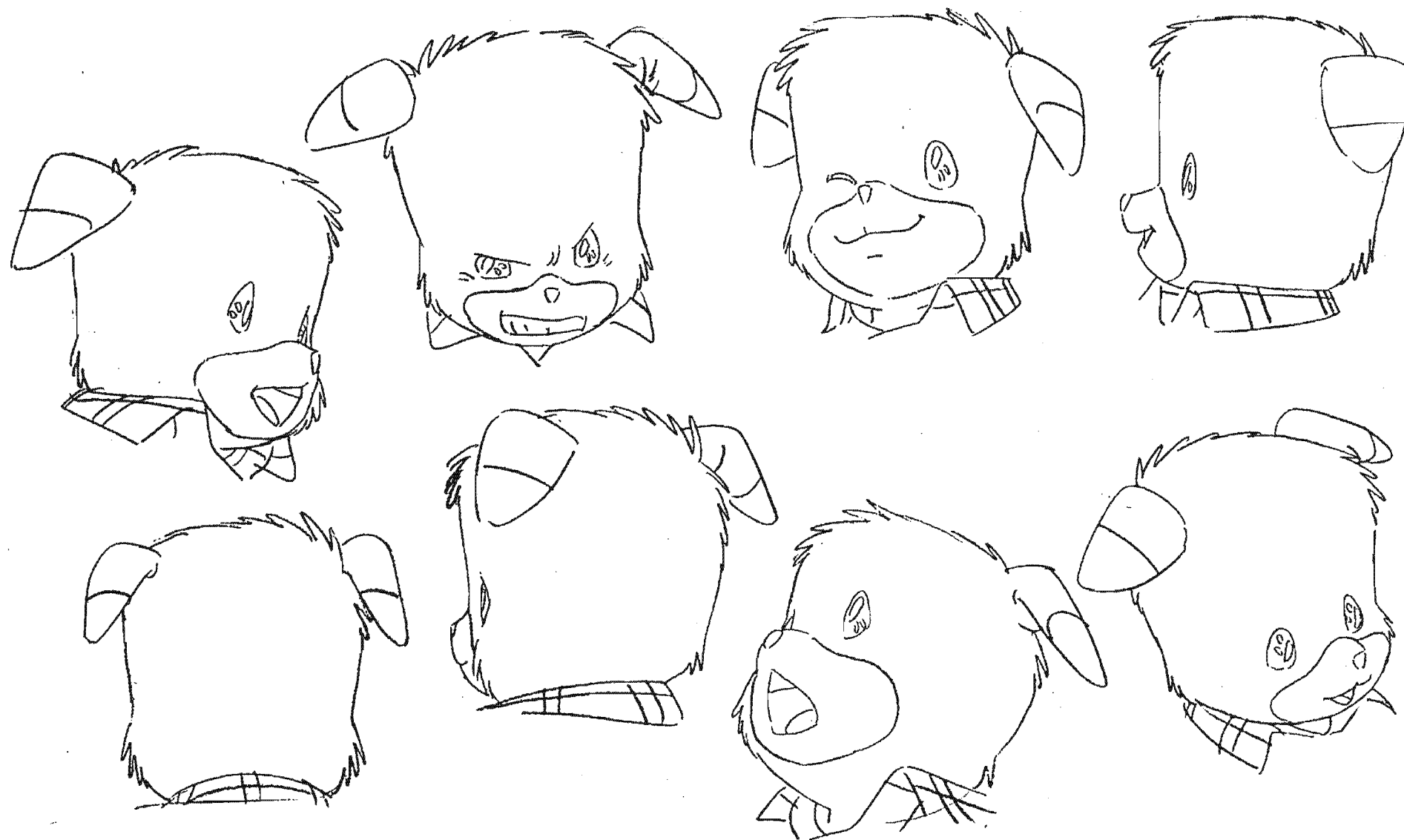

フロリス・テリヤ①

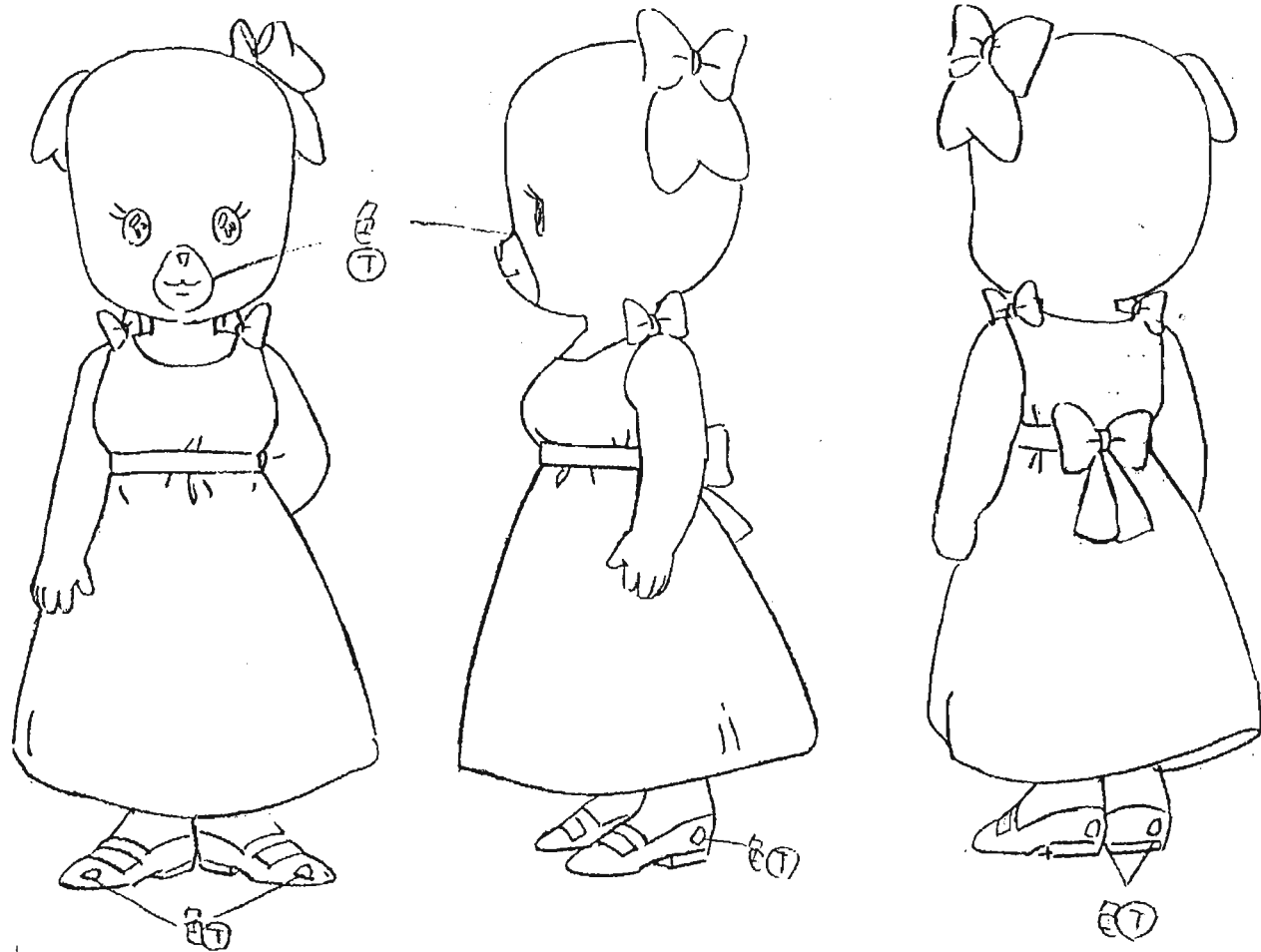

70-リス・テリア②

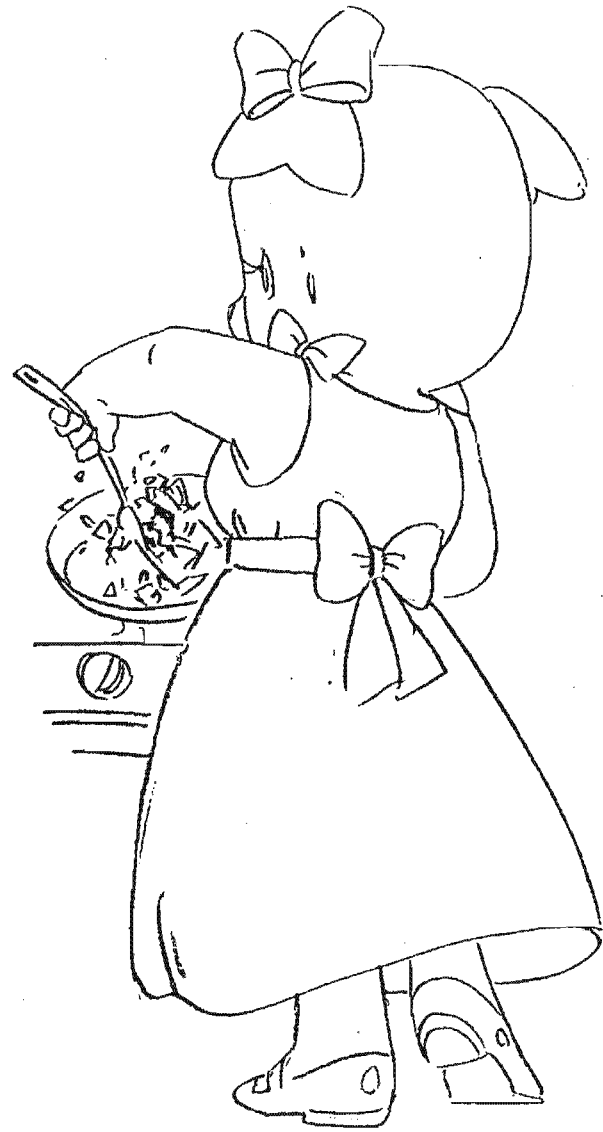

フィリップ・テリア① (改訂)

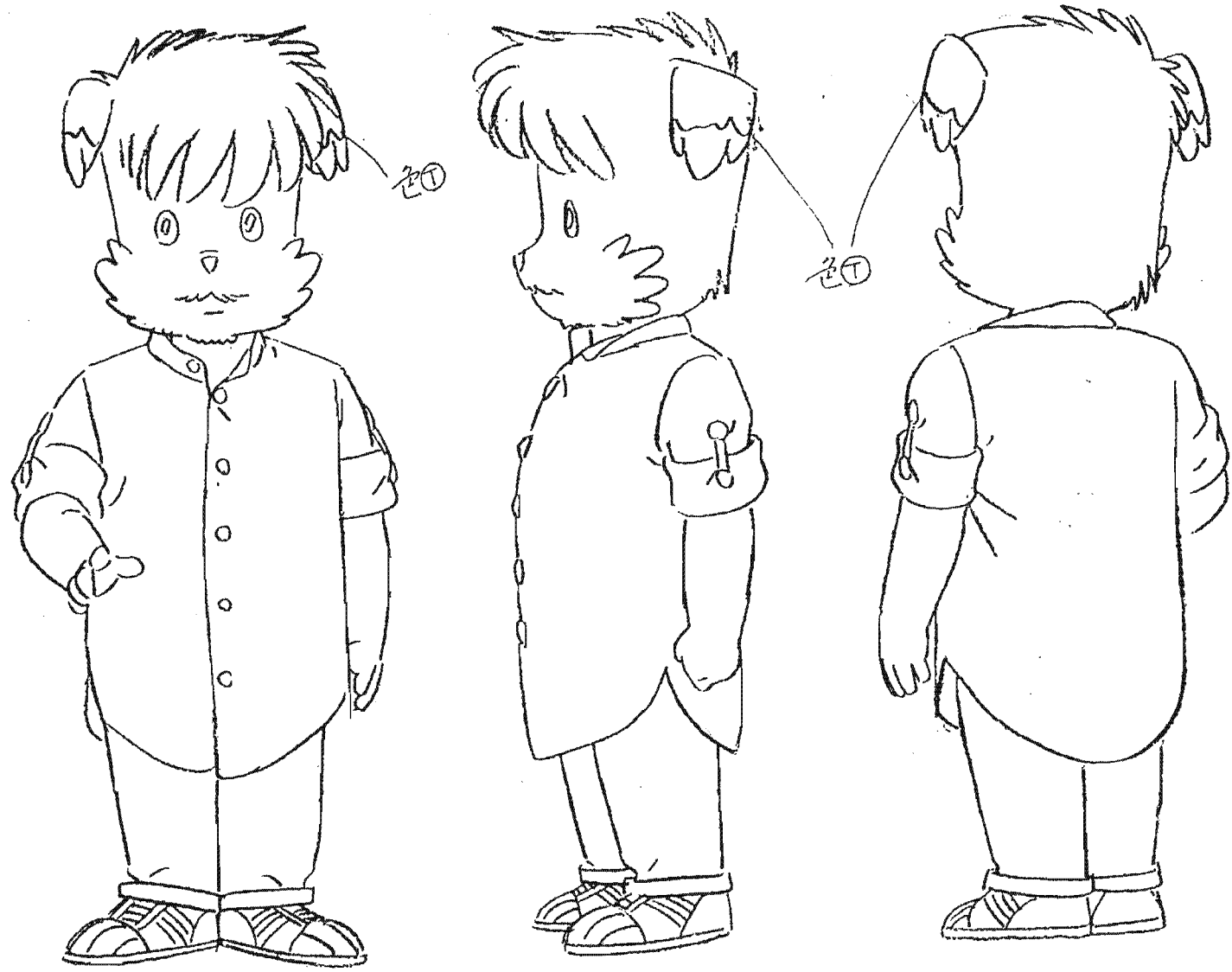

フリップ・テリア 改訂



フリッポテリア改訂





スケッチブック
& デイブック

(キャラクター改訂)

ジョーイの母写真用

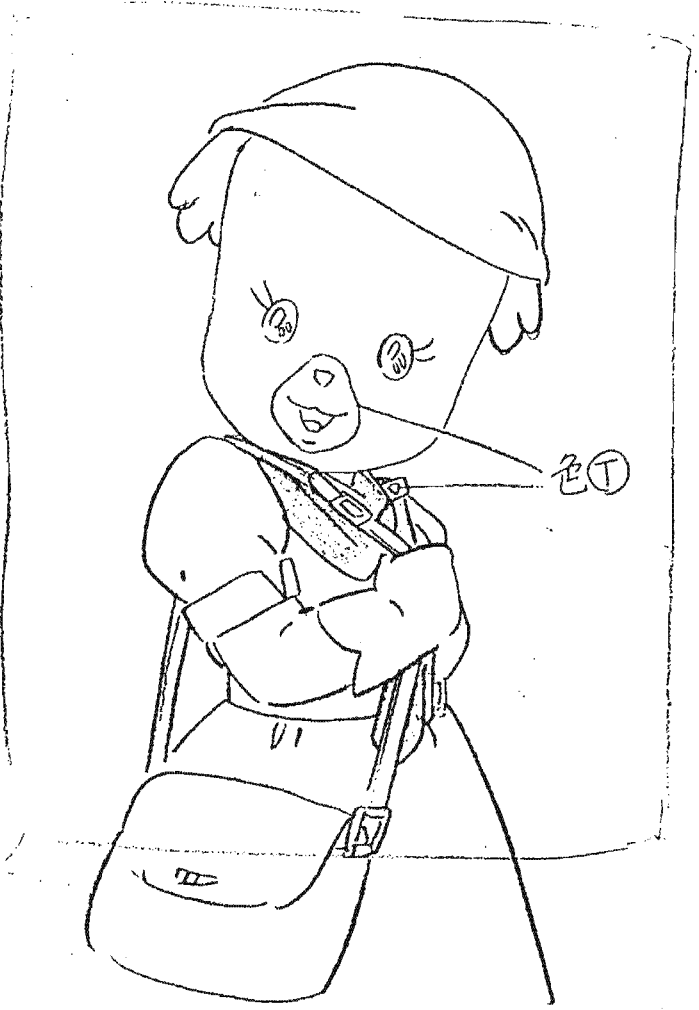
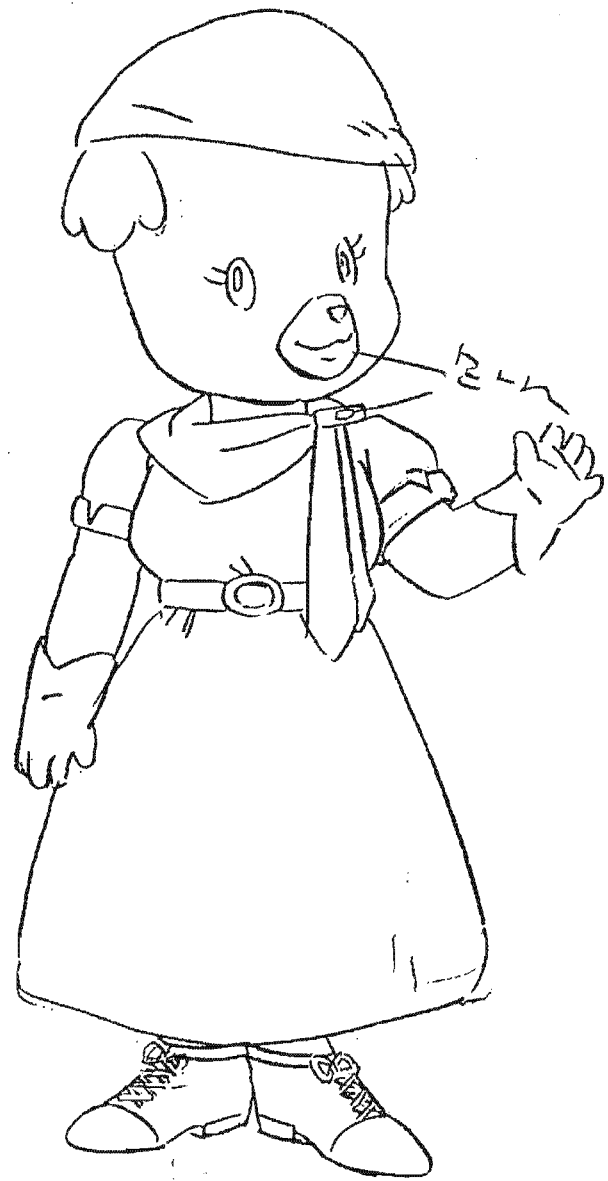

羊ファミリー

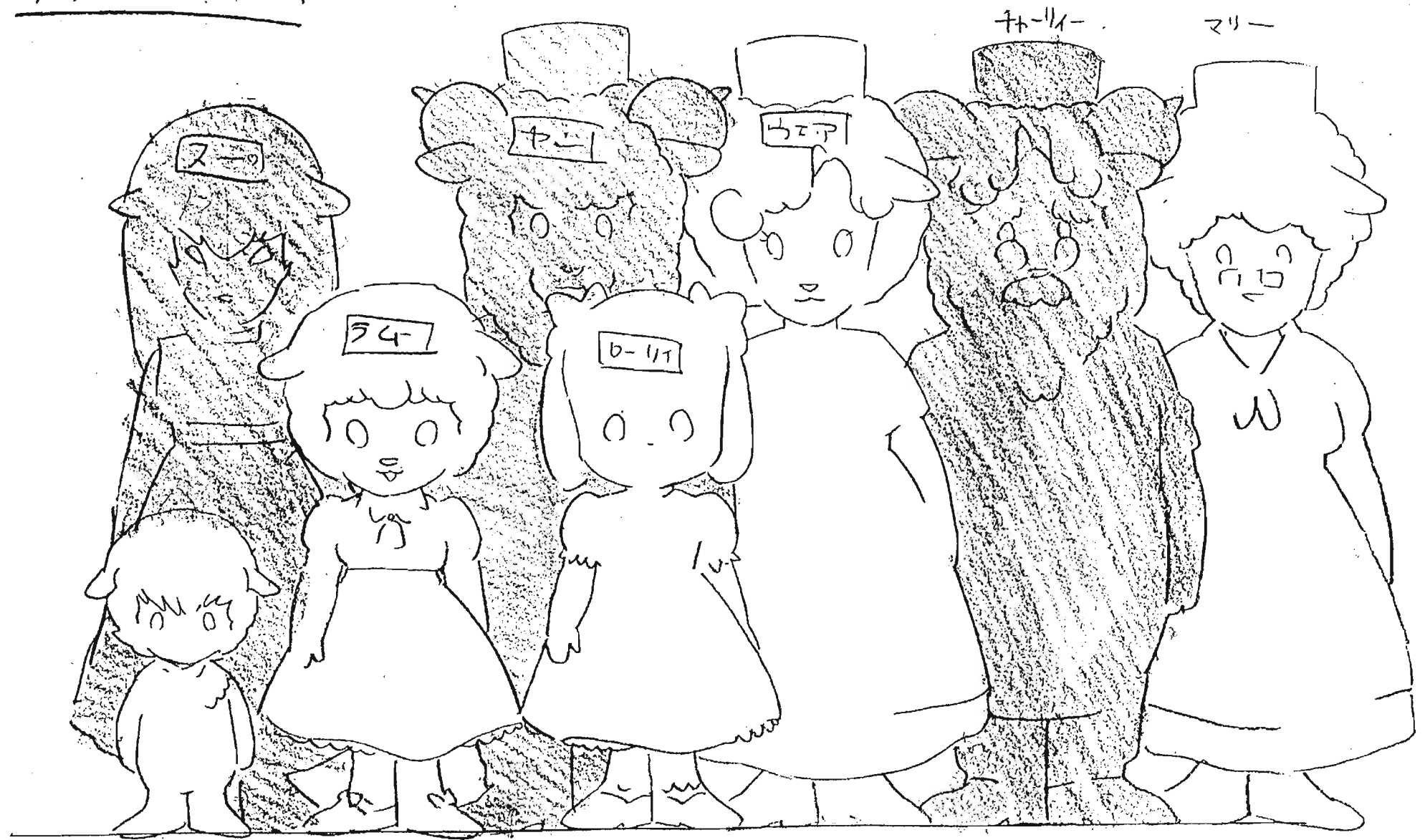

76 ①

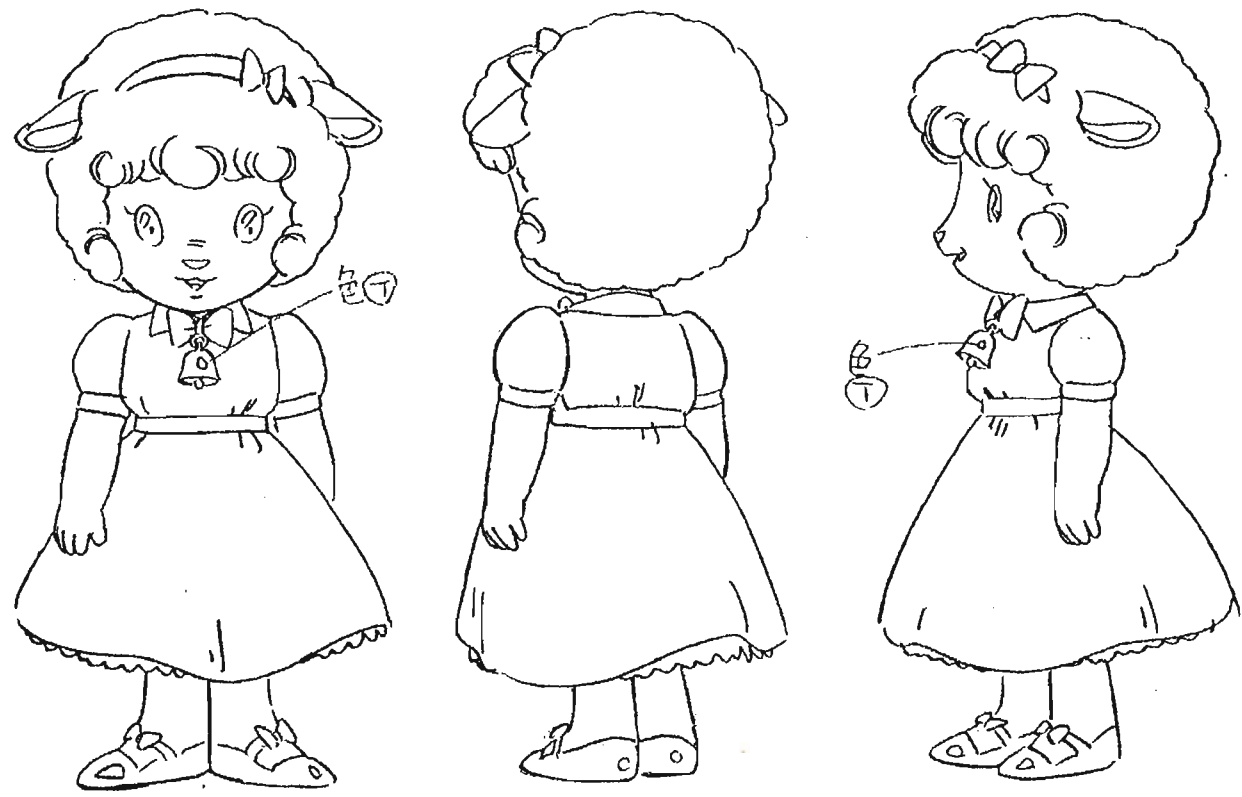

74②



ラム③



羊赤子 ①



羊赤子 ②



スウ①
ラムの姉

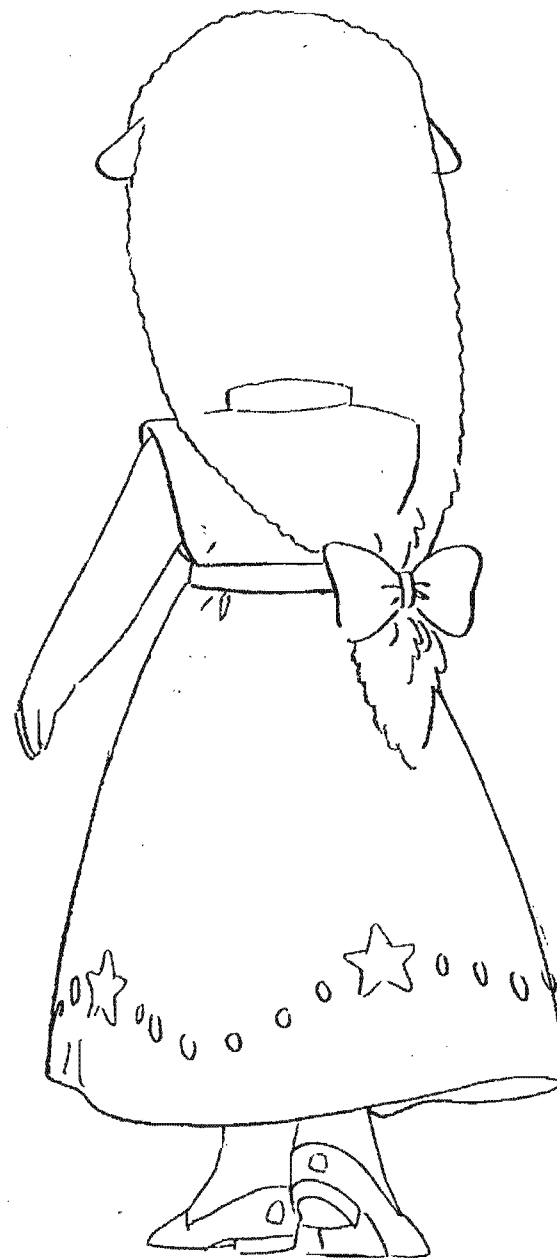
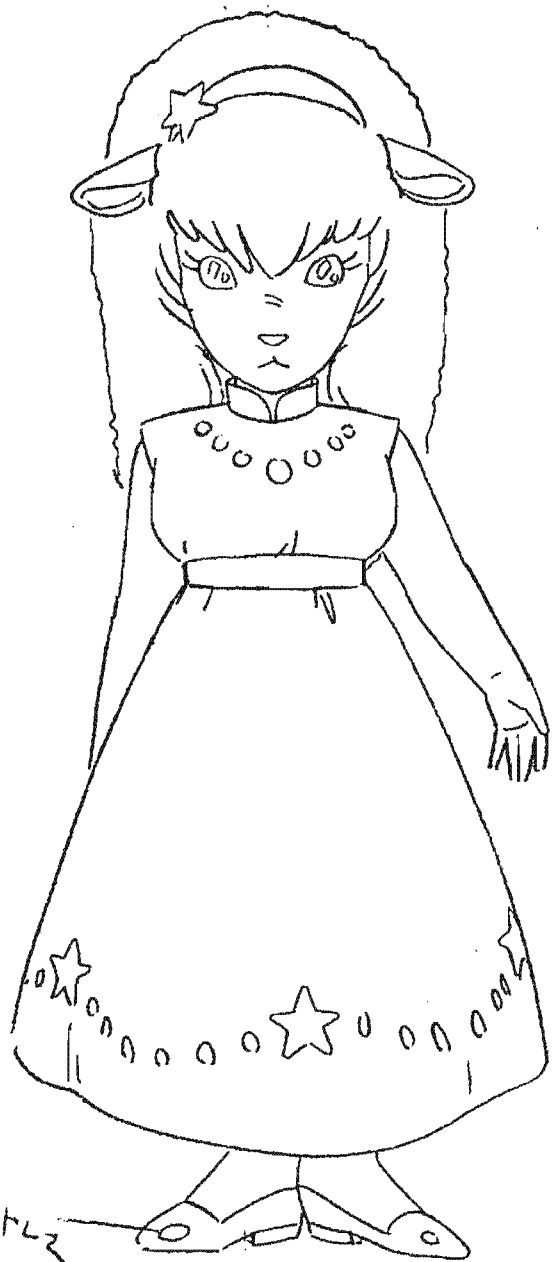

2/12

スウ②



スウ③



星の形はシャープですか
先端はとがらせないで下さい

スウ④



アノ①

羊の父

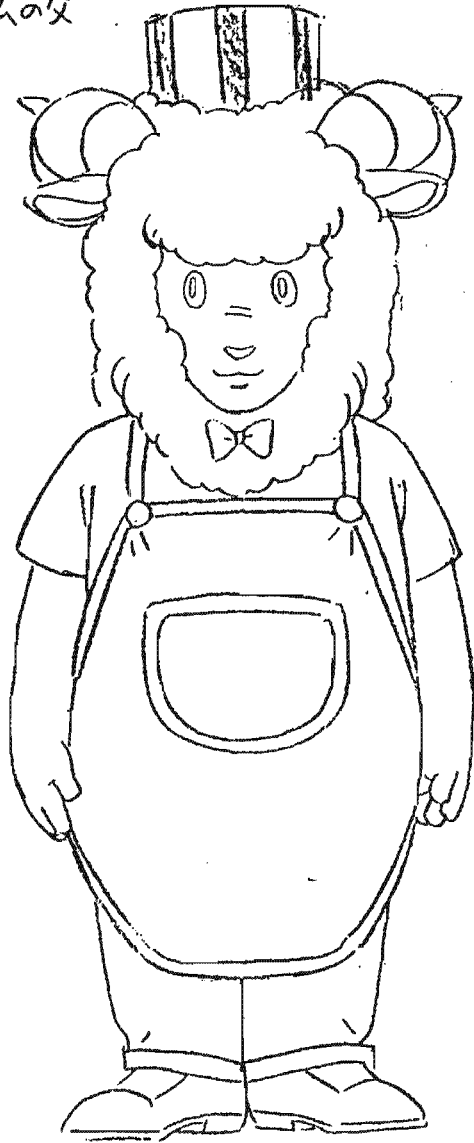

②

ヤン ②





ヤン ③



ウェア①
ラムの♀

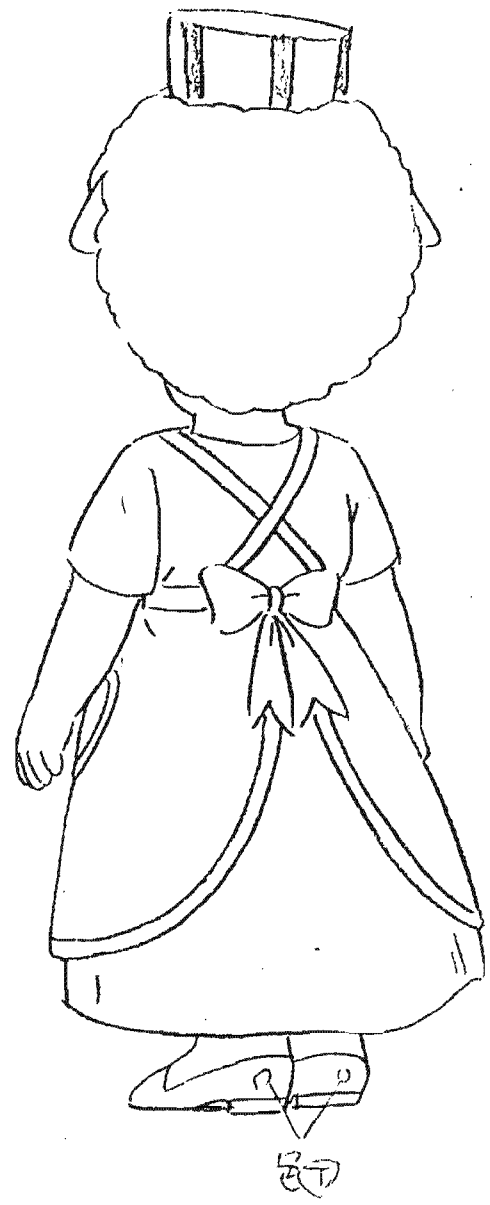

ウェア②



色トス

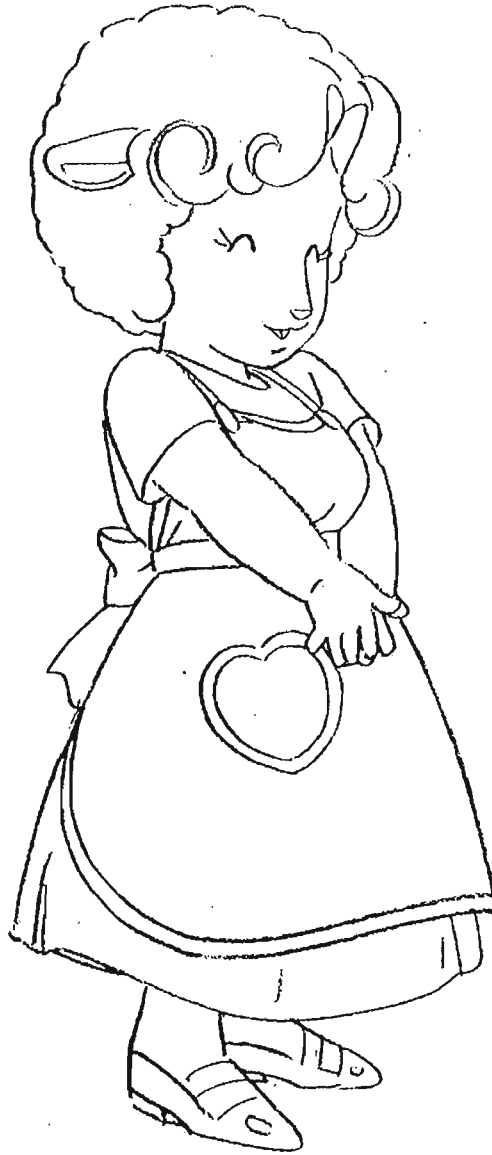

ウエアー③

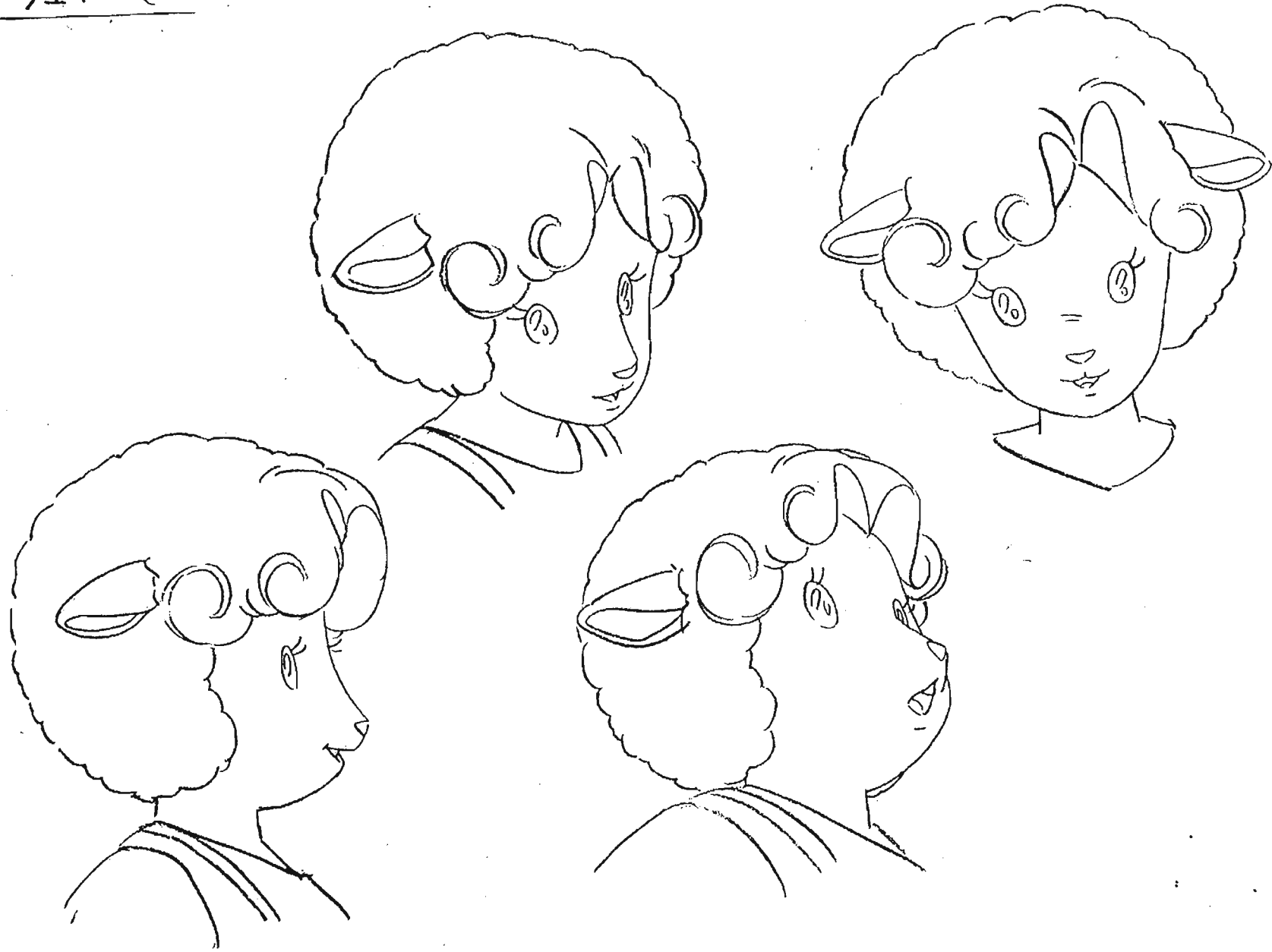

76-111-①
ラムの祖父

58

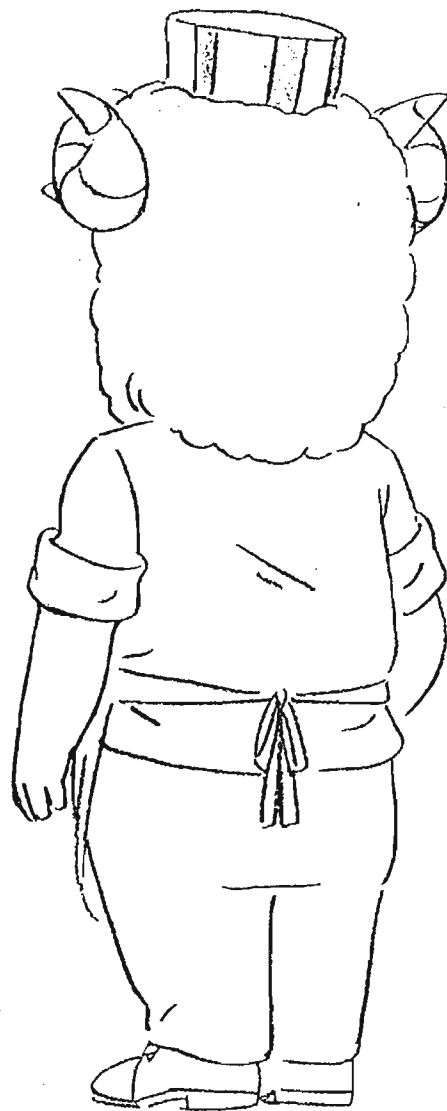

4b-11c-②



マリ①
ラムの祖母

60



マリー②



巨クマファミリー

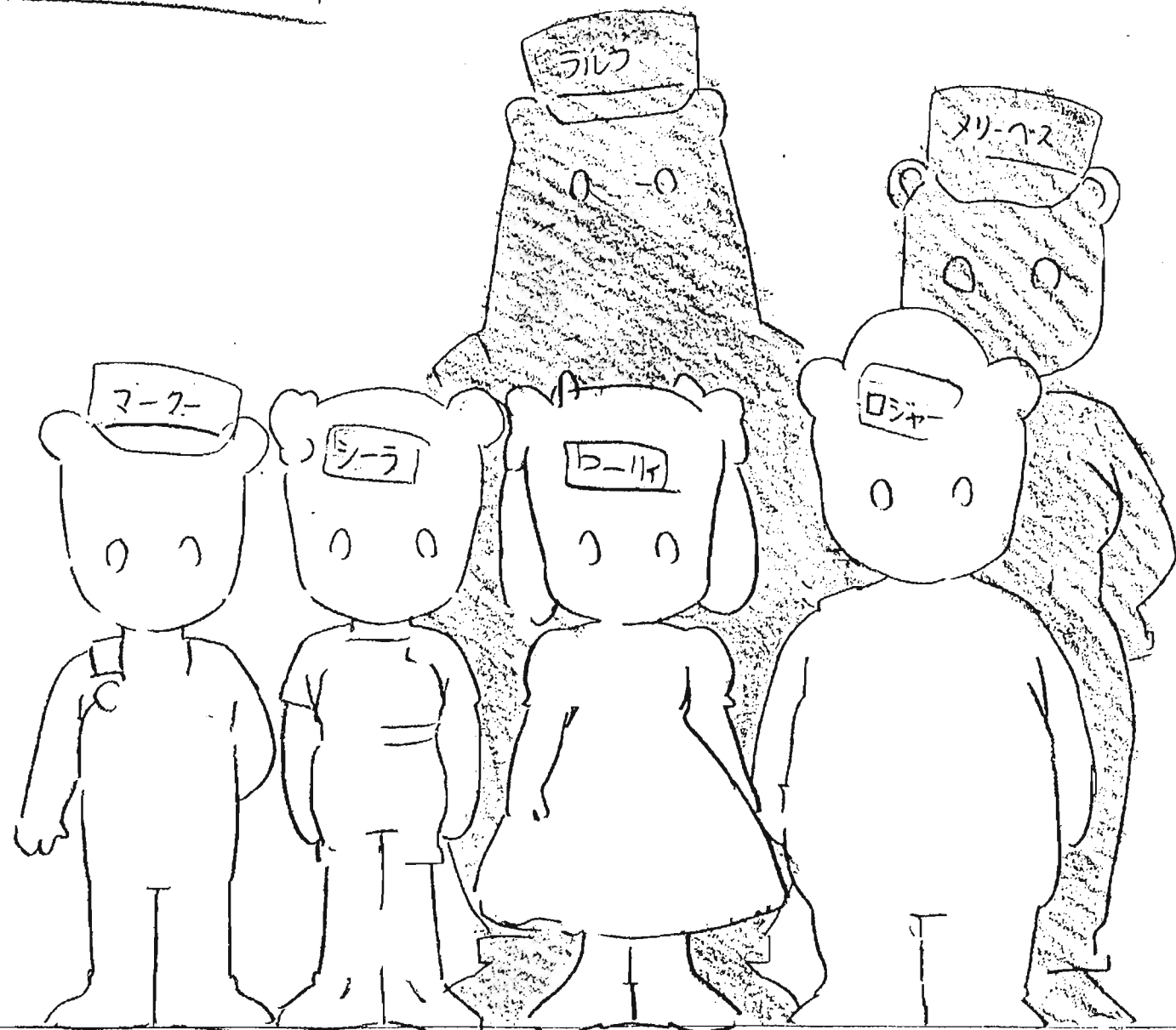

シーラ・ホワイト①

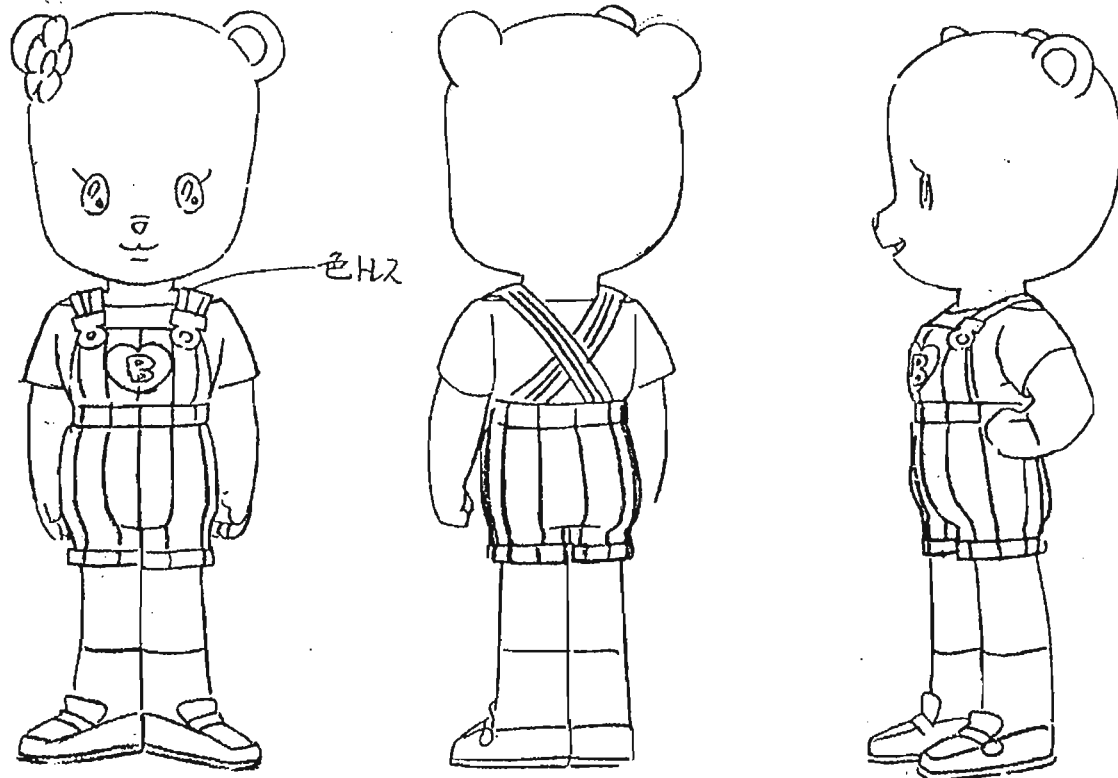

シーラ・ホワイト②

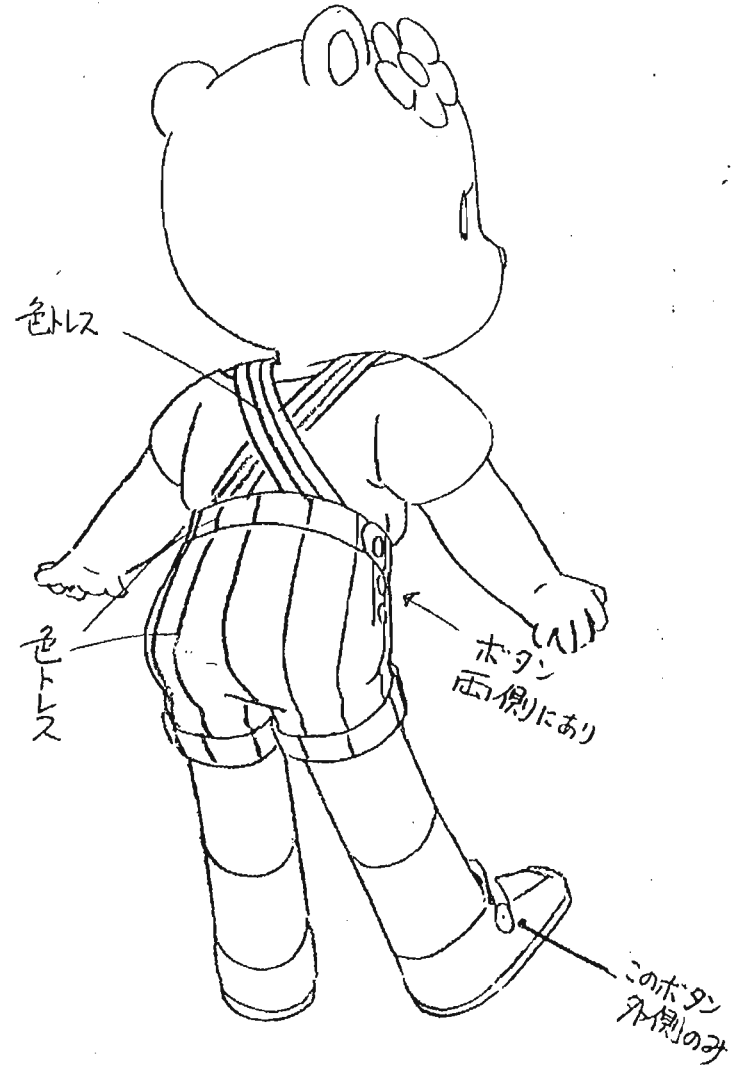

シーラ・ホワイト③

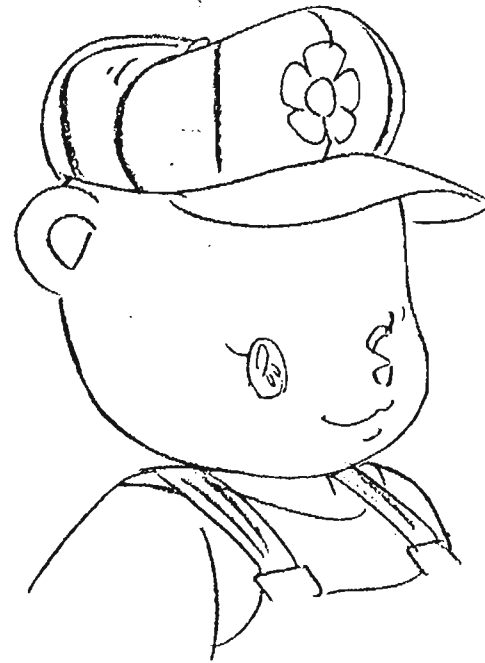
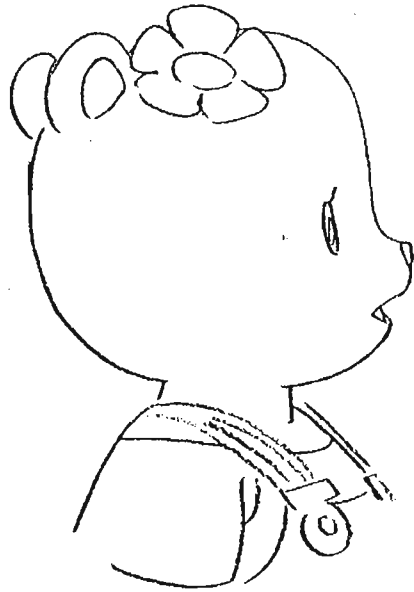
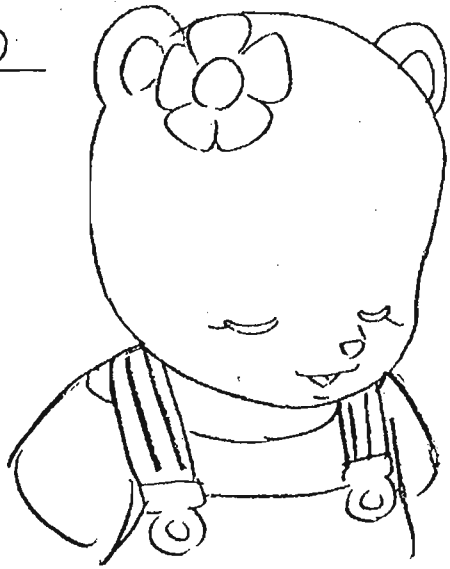
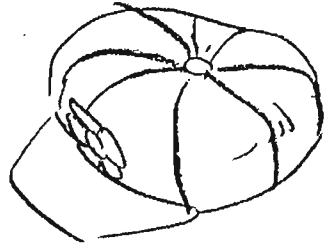

ロジャー・ホワイト ①

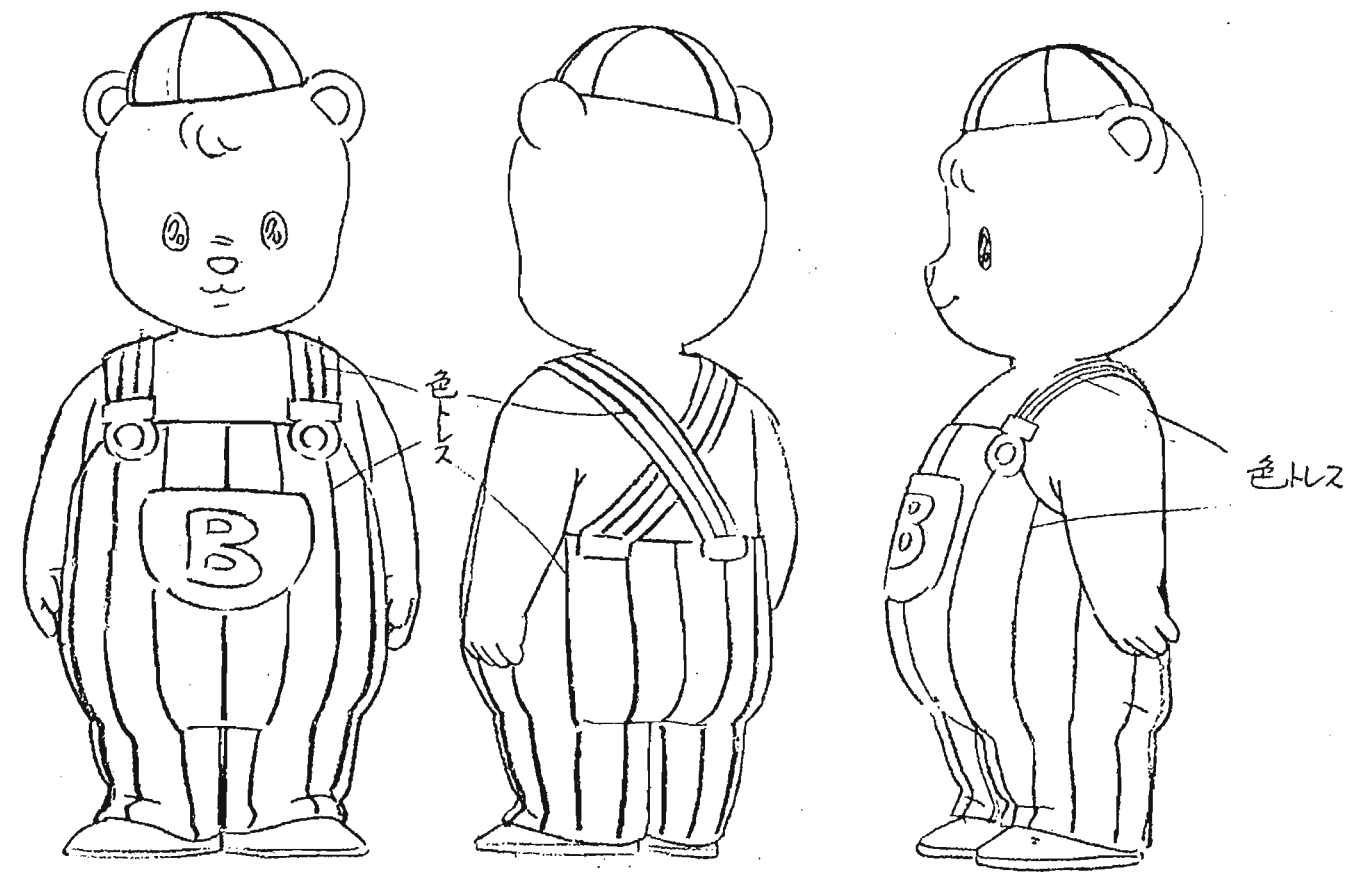

ロジャー・ホワイト②

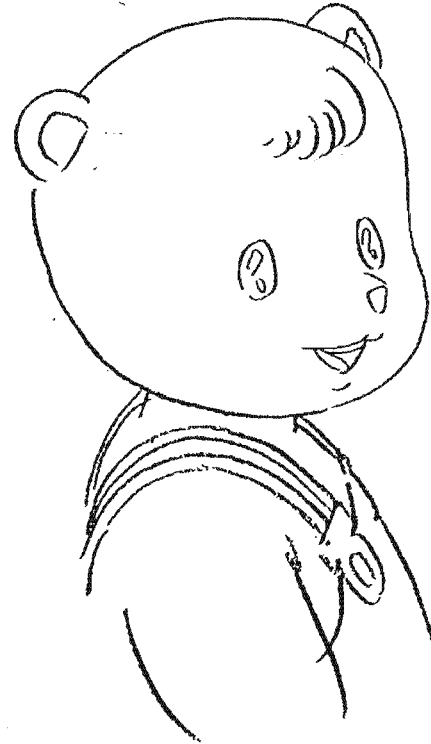
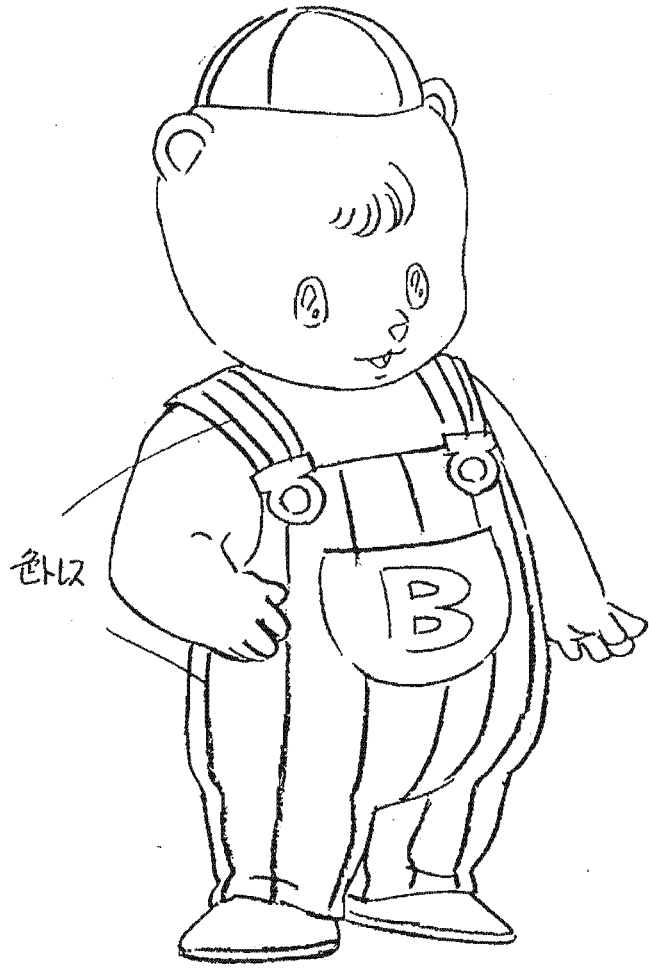

マーク・ホワイト ①

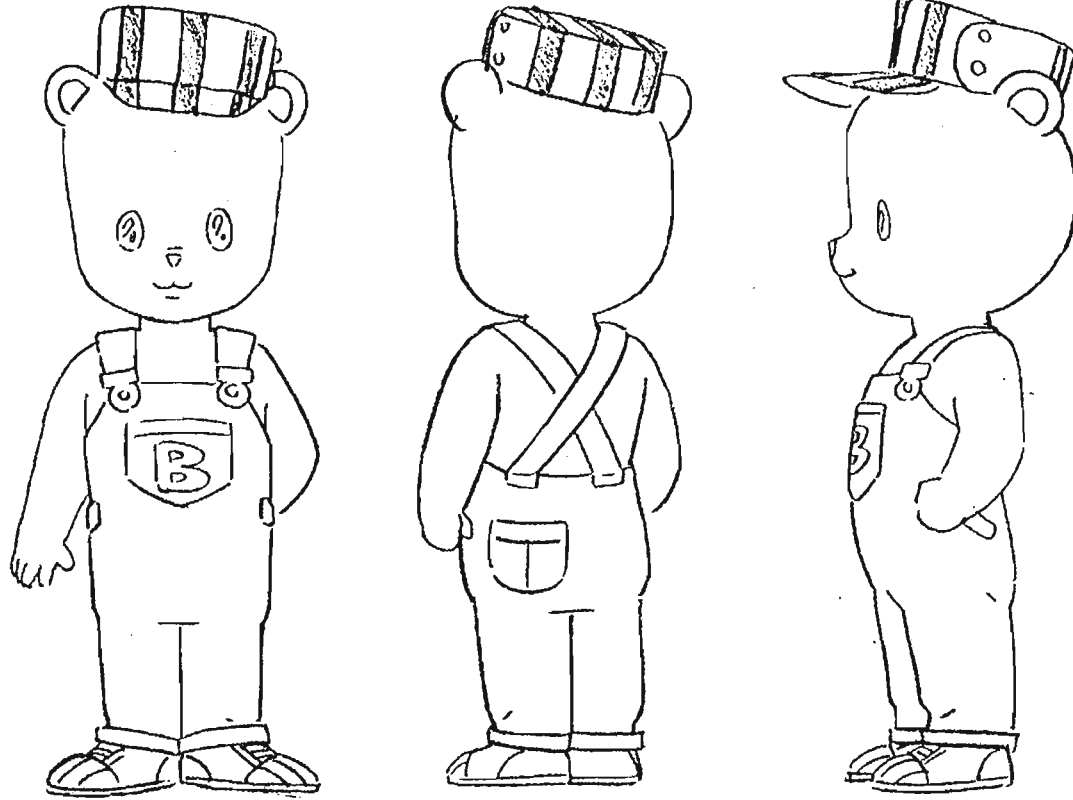

マーク・ホワイト ②

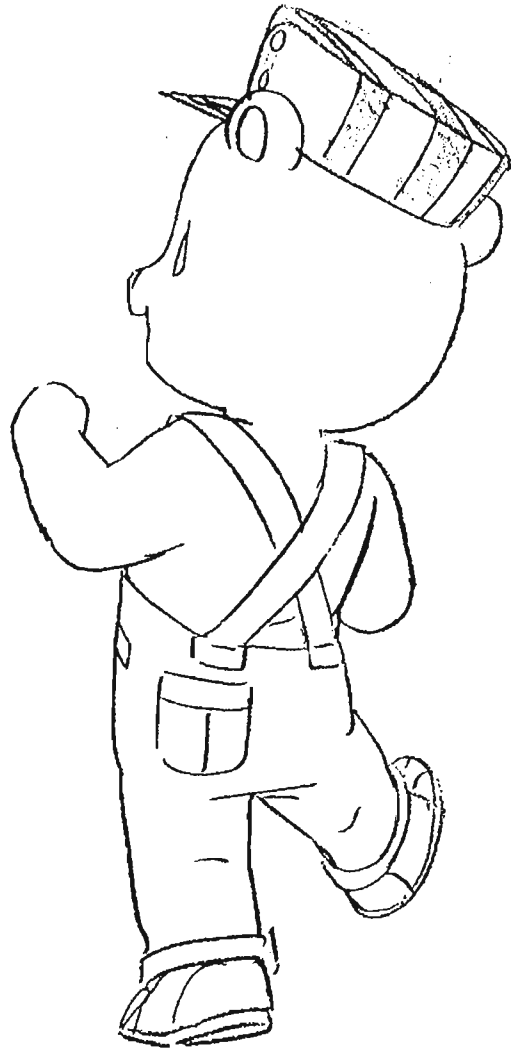
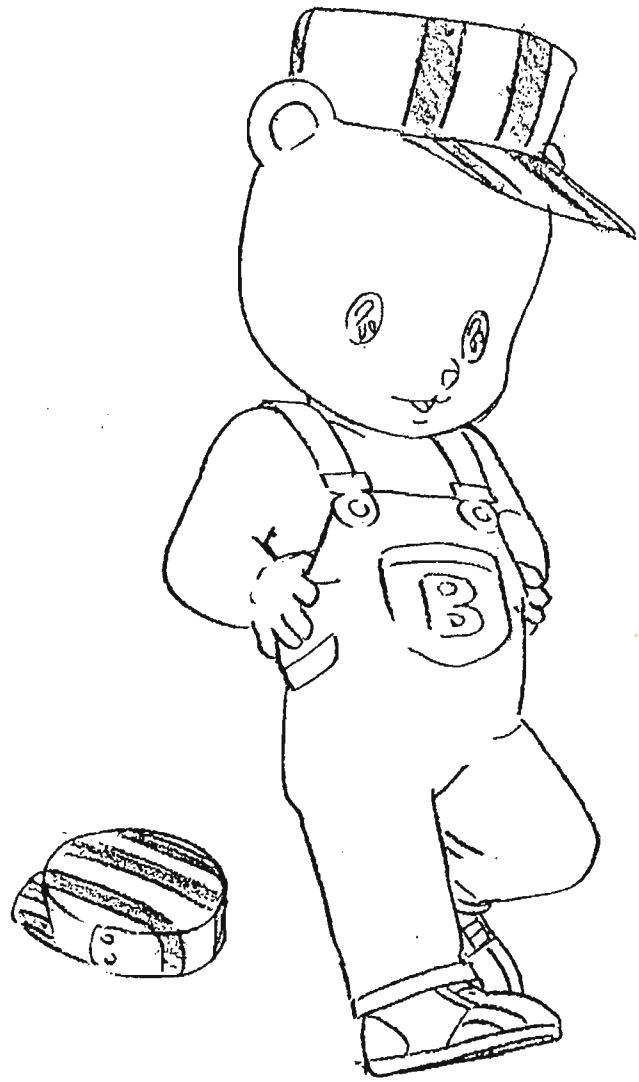

ラルフ・ホワイト②

(11)

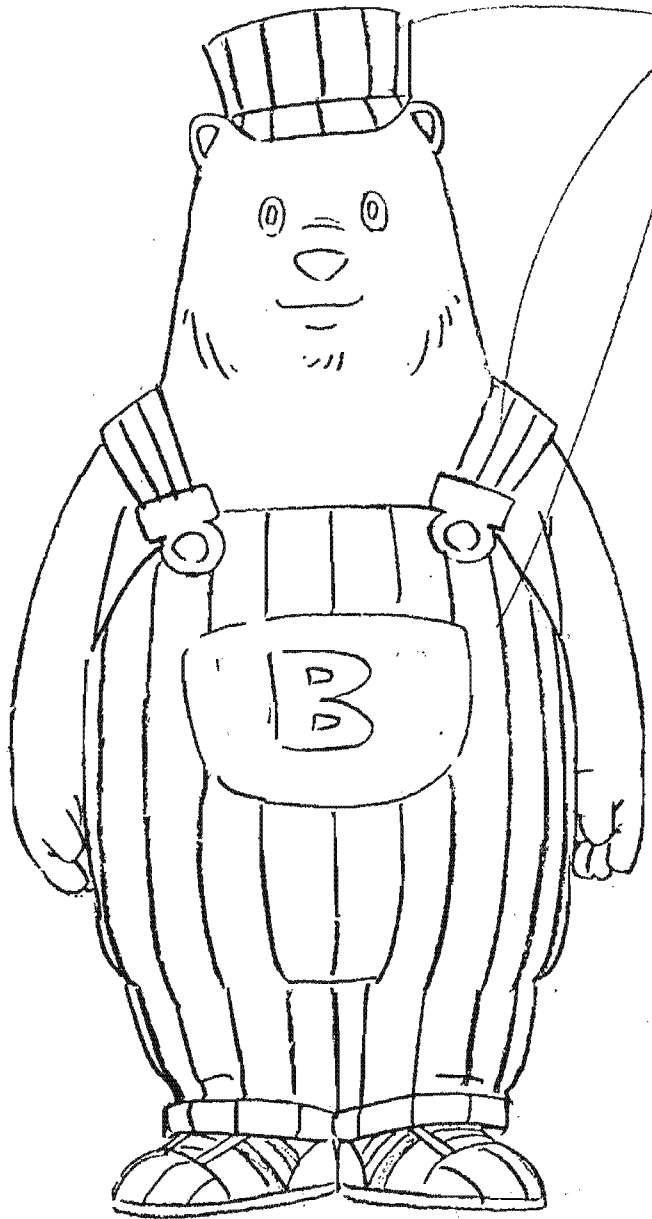

色ハズ

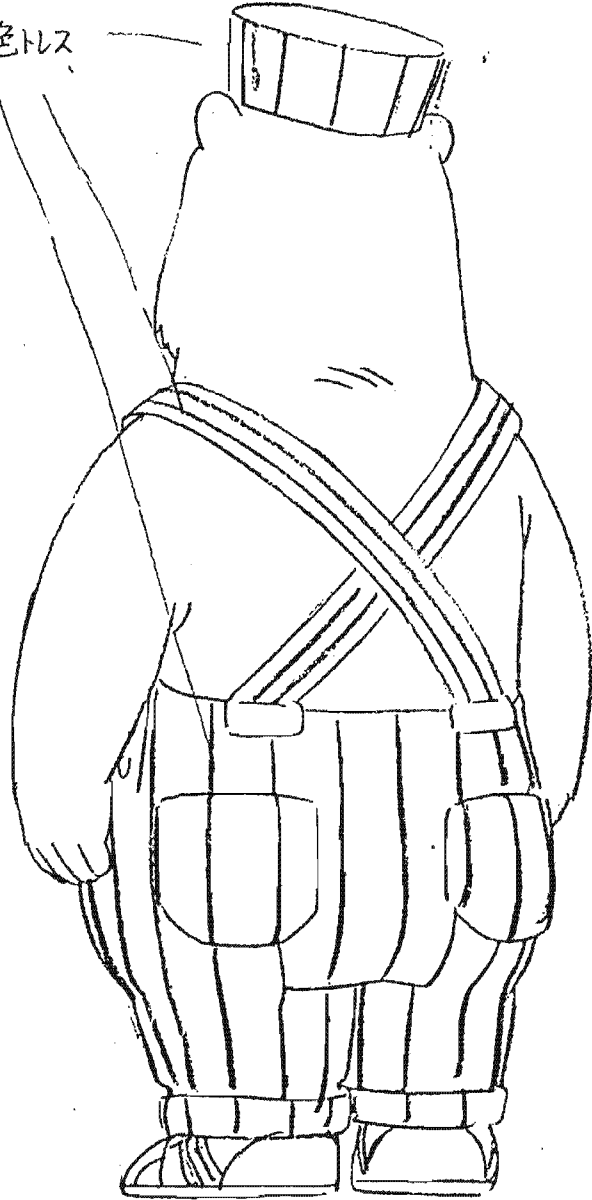

色ハズ

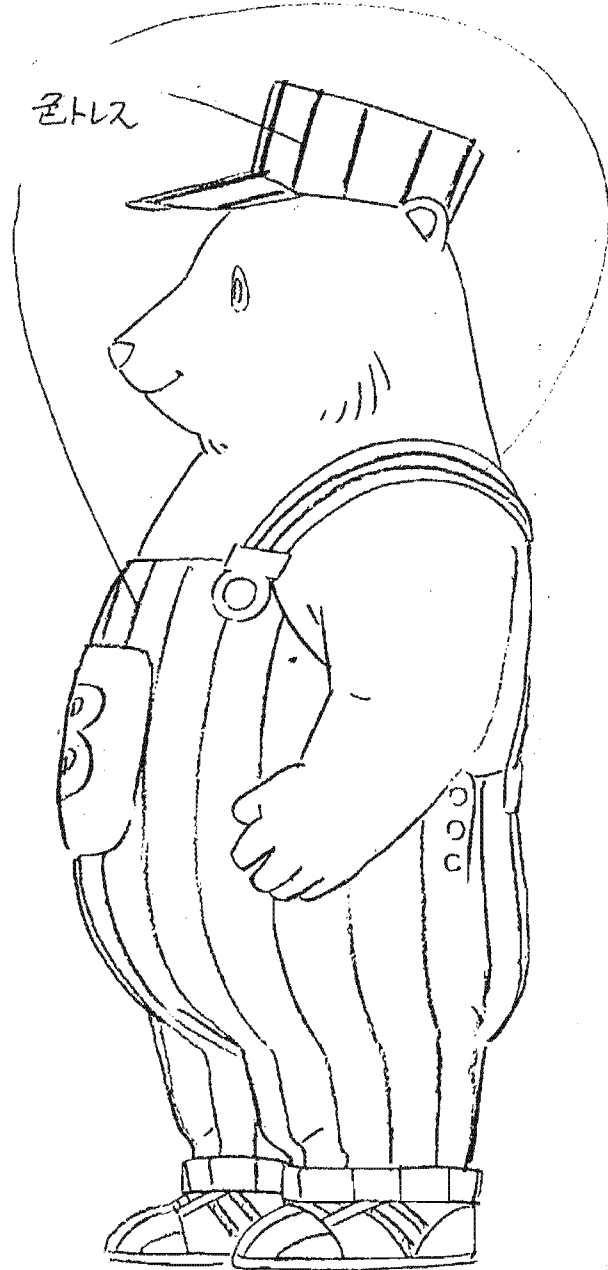

ラルフ・ホワイト ①

色ハズ

色ハズ

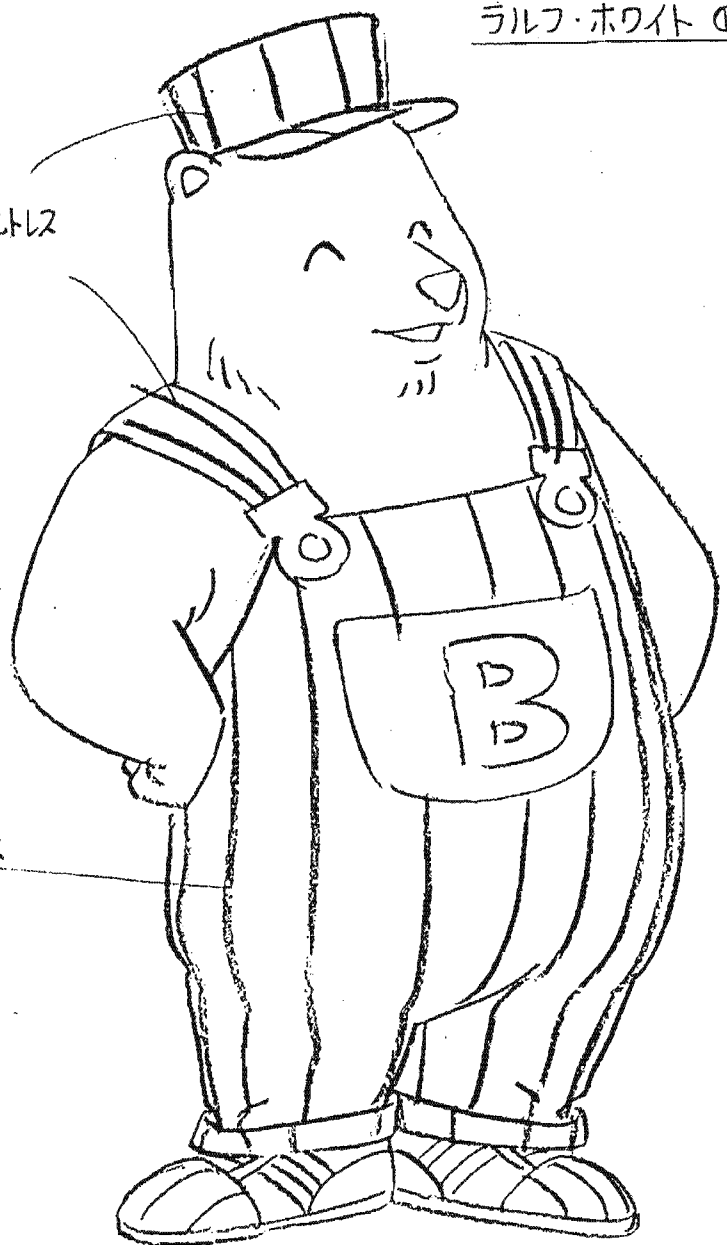

ラルフ・ホワイト③

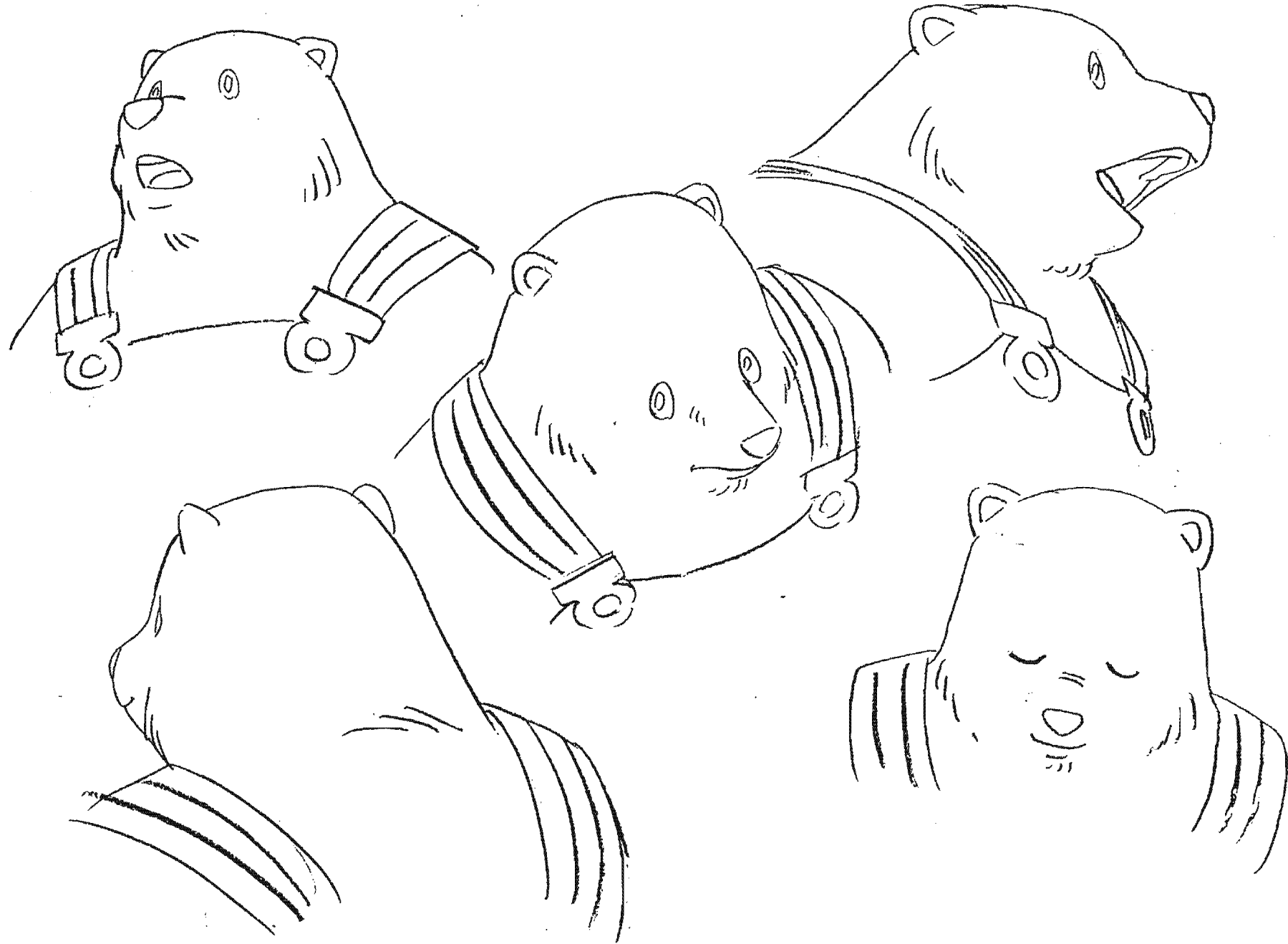

(73)

メリヘス・ホワイト①

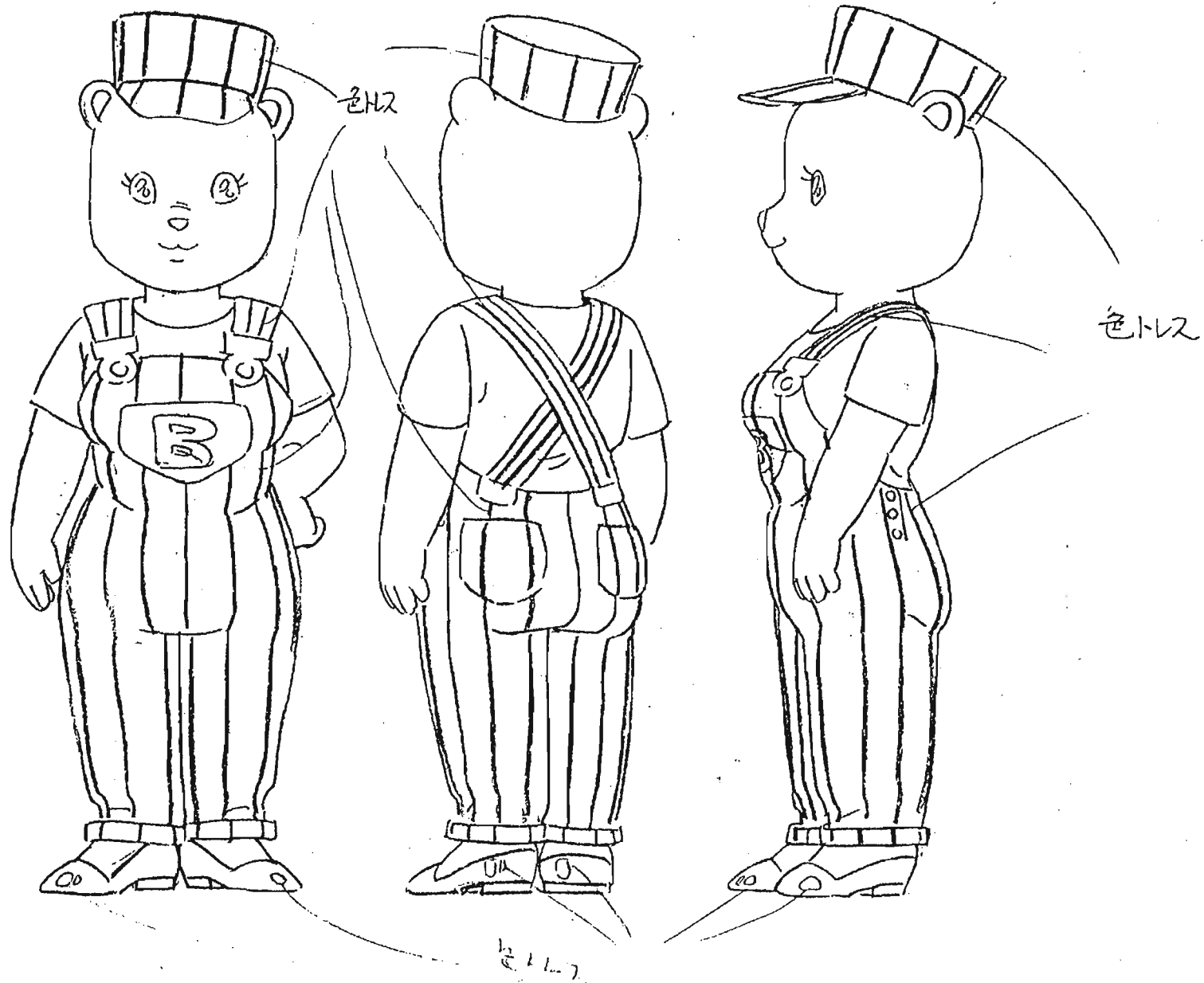

メリーベス・ホワイト②

改訂

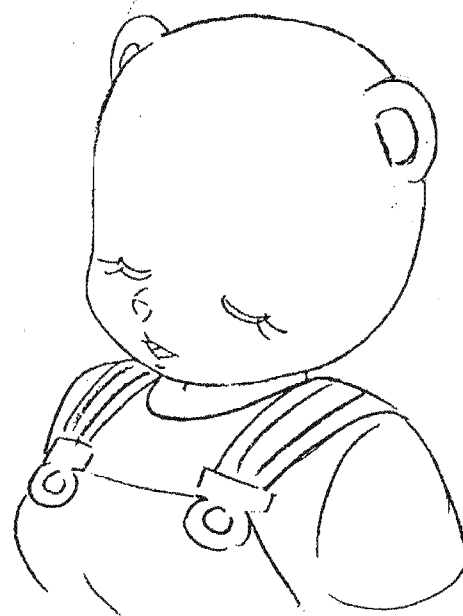

色ハズ

ヨ-ダ-ダ-ダ. ネコダ 利率 比較図

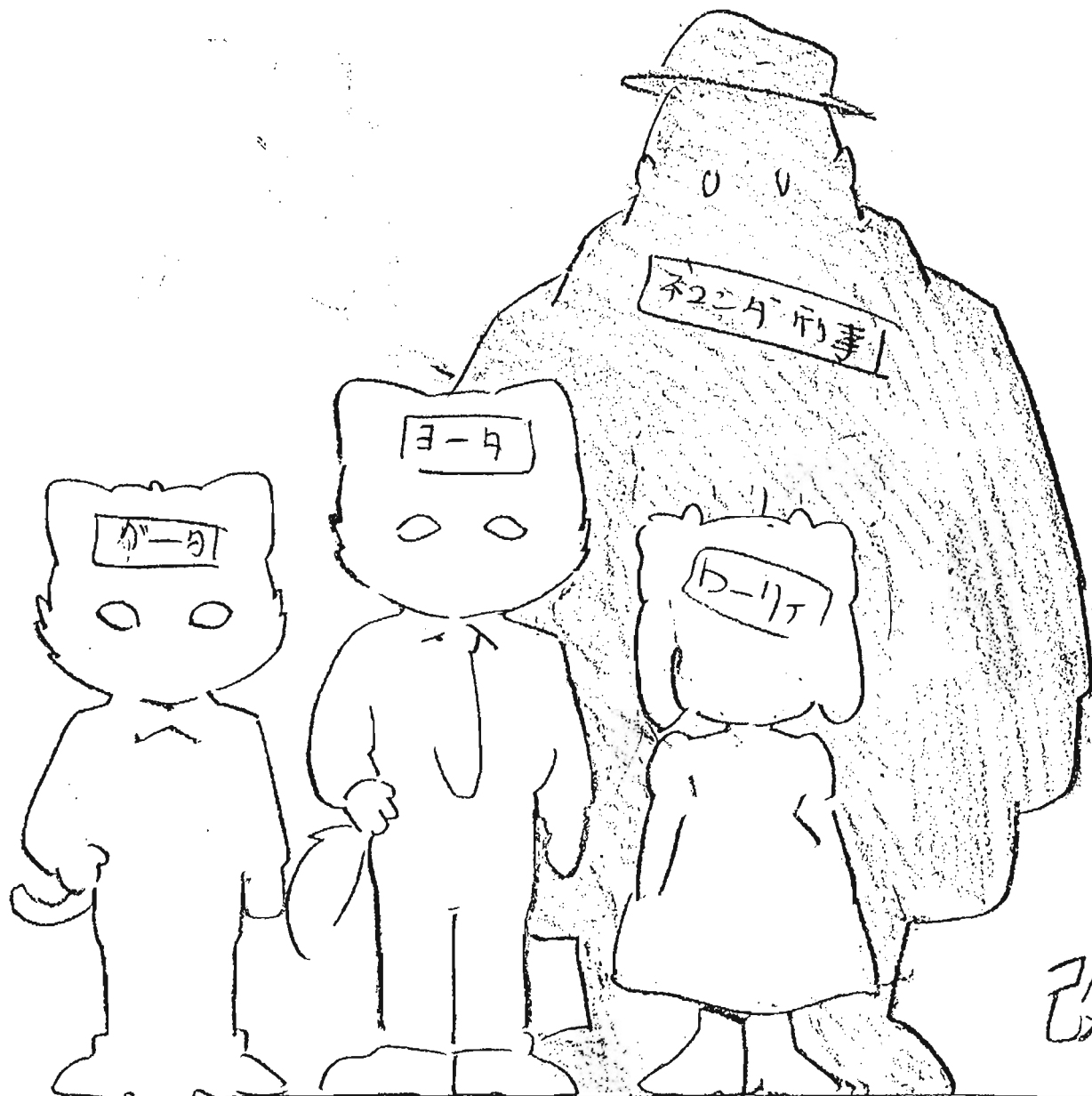

改訂









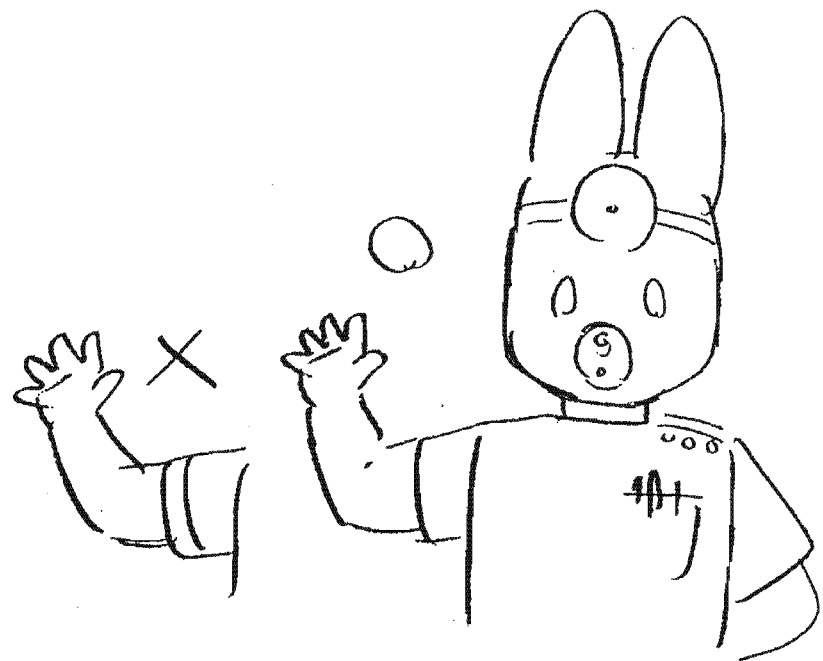

ジョージの服のソテの線ナシです

作画上の注意

ヨ-タ・ク-タ 描き分けて下さい

ク-タ

ヨ-タ

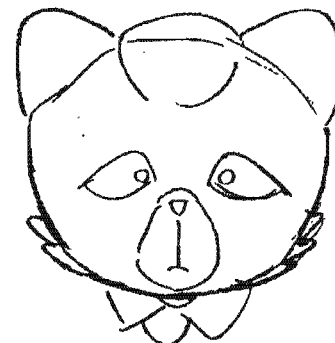

鼻の下の長さは、(あるいは目の形状)
表情によって無視しても
かまいません

① 6-E

80

+

+

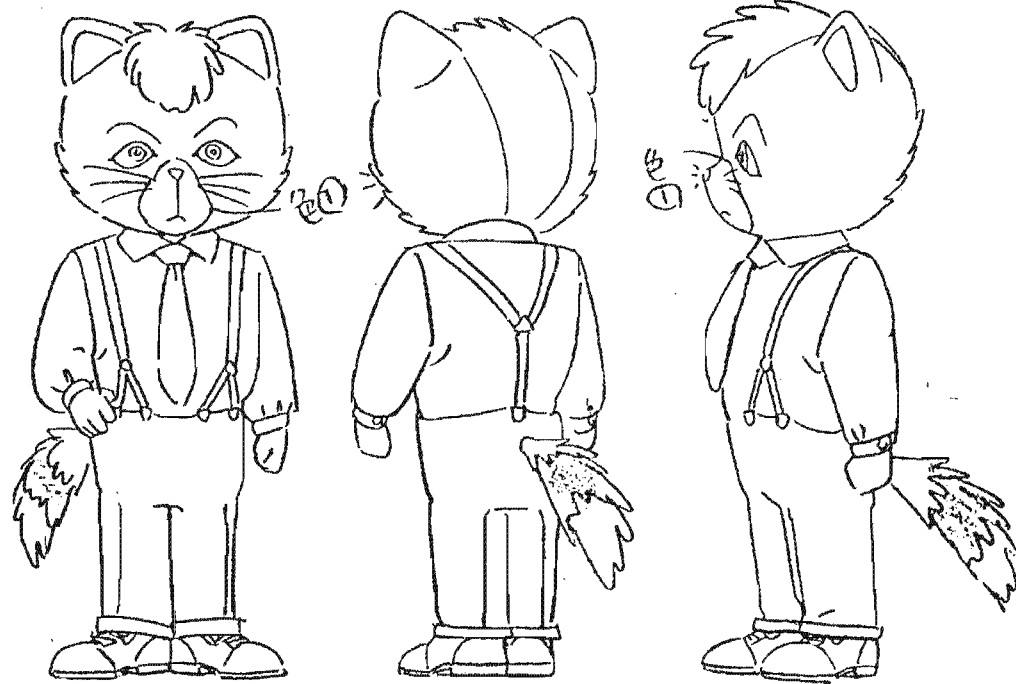

+

+

3-9 ② 1:172

+



+



+

+

③-9-E



④ 6-E



グータ①

(84)

+

+

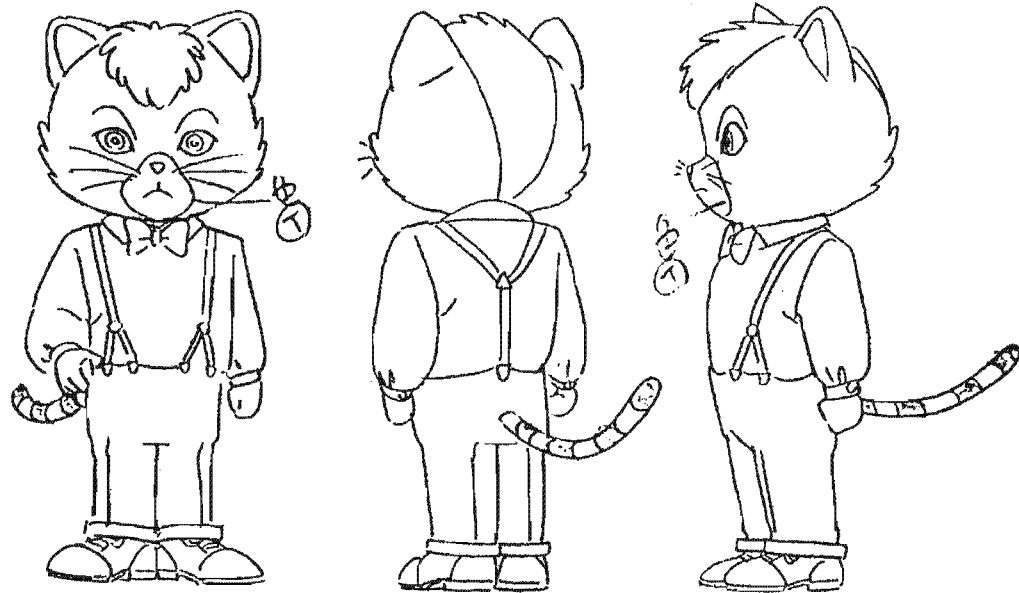

+

+

17-9 ② #2772

+



+

+

+



7-7④

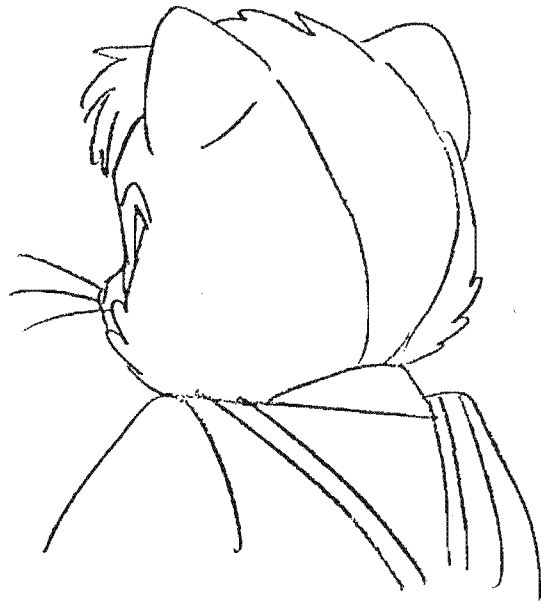

7-7 ①

(8)





クータ



ヨータ

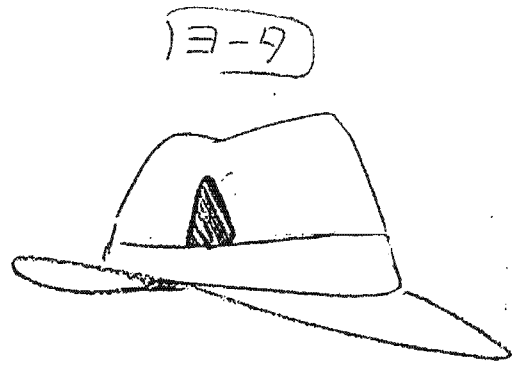

ヨータ

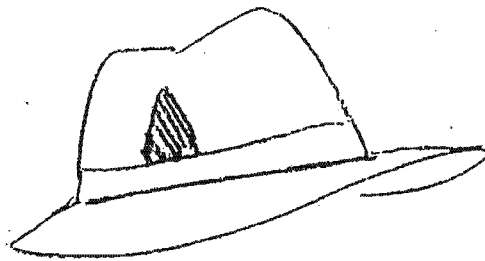

クータ

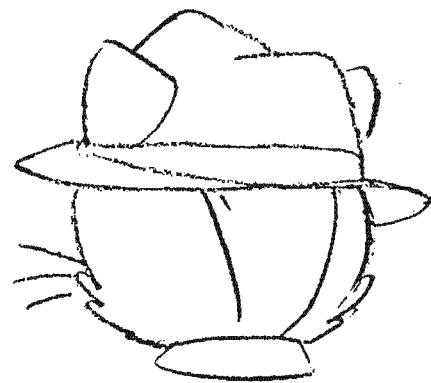
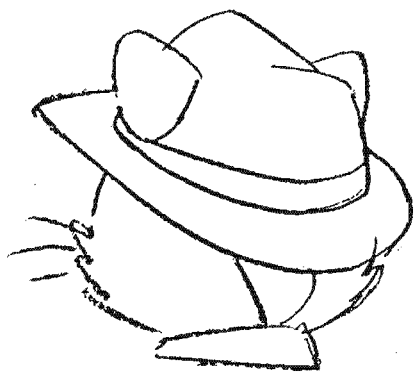

クータ)の帽子
ヨータ



ヨーダ・ゴータ スーツ姿



メイプルタウン物語
前の国のバームタウン

#4

カモメ女教師

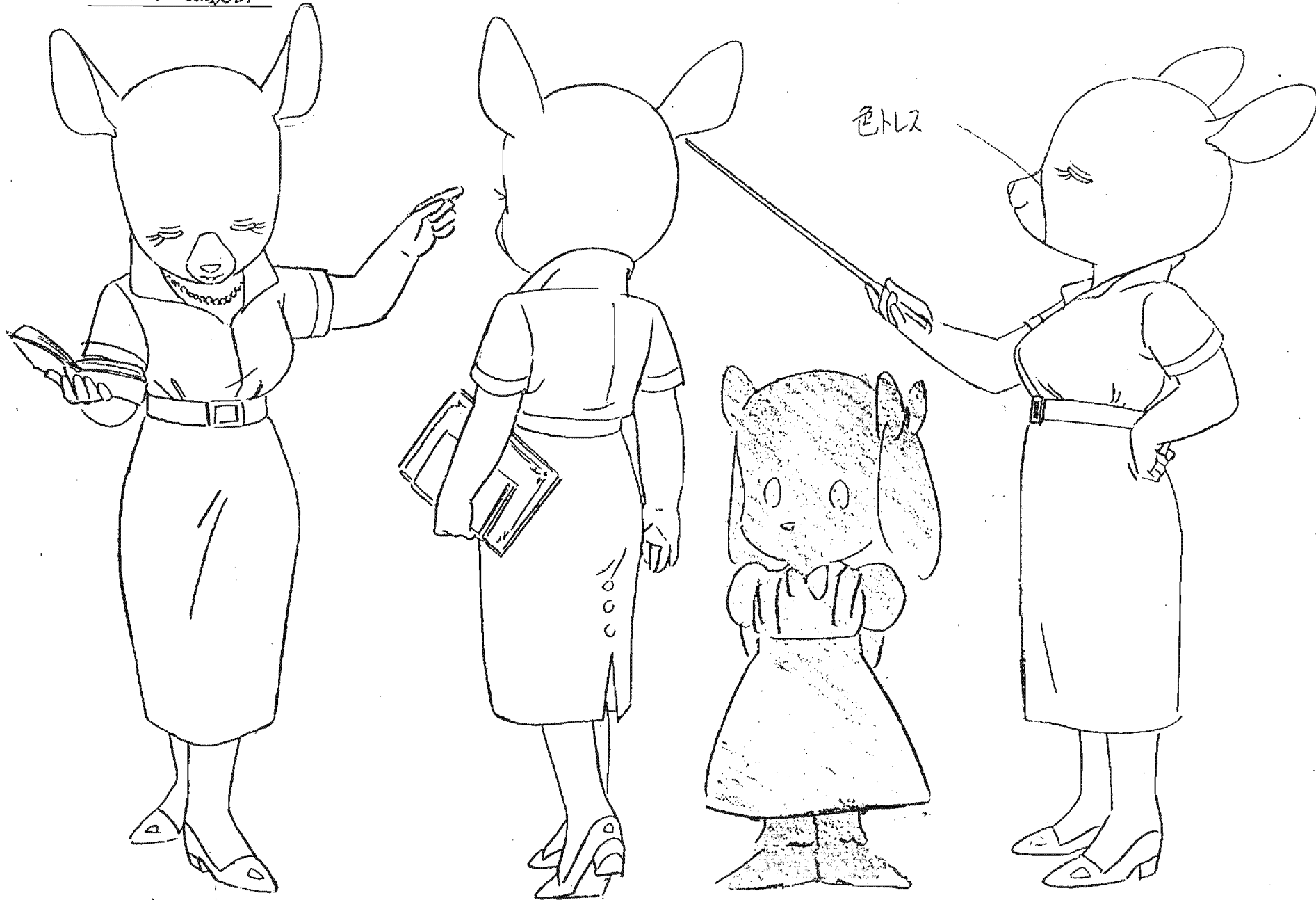

色紙

カモメ女教師

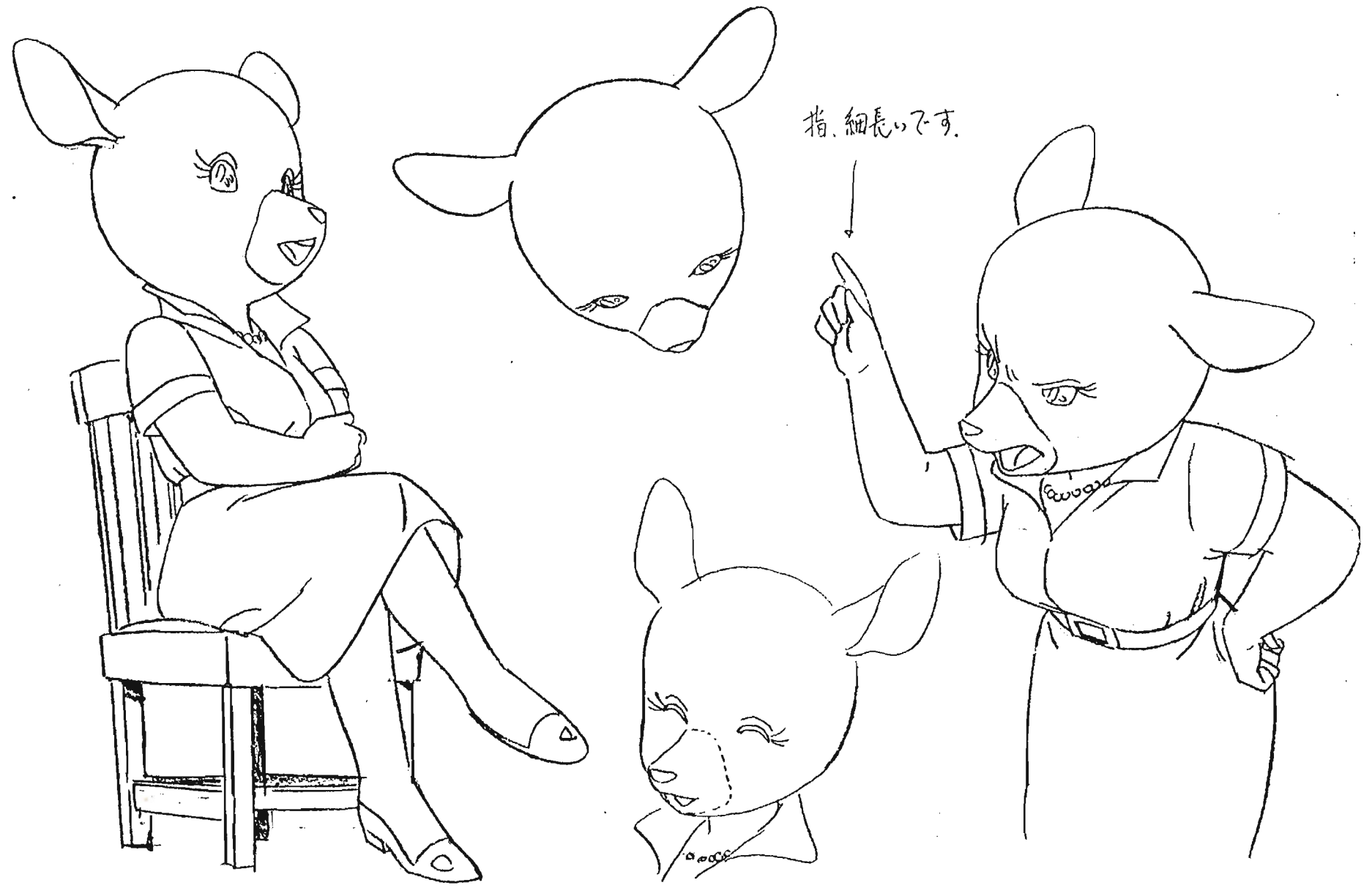

カモシカ女教師

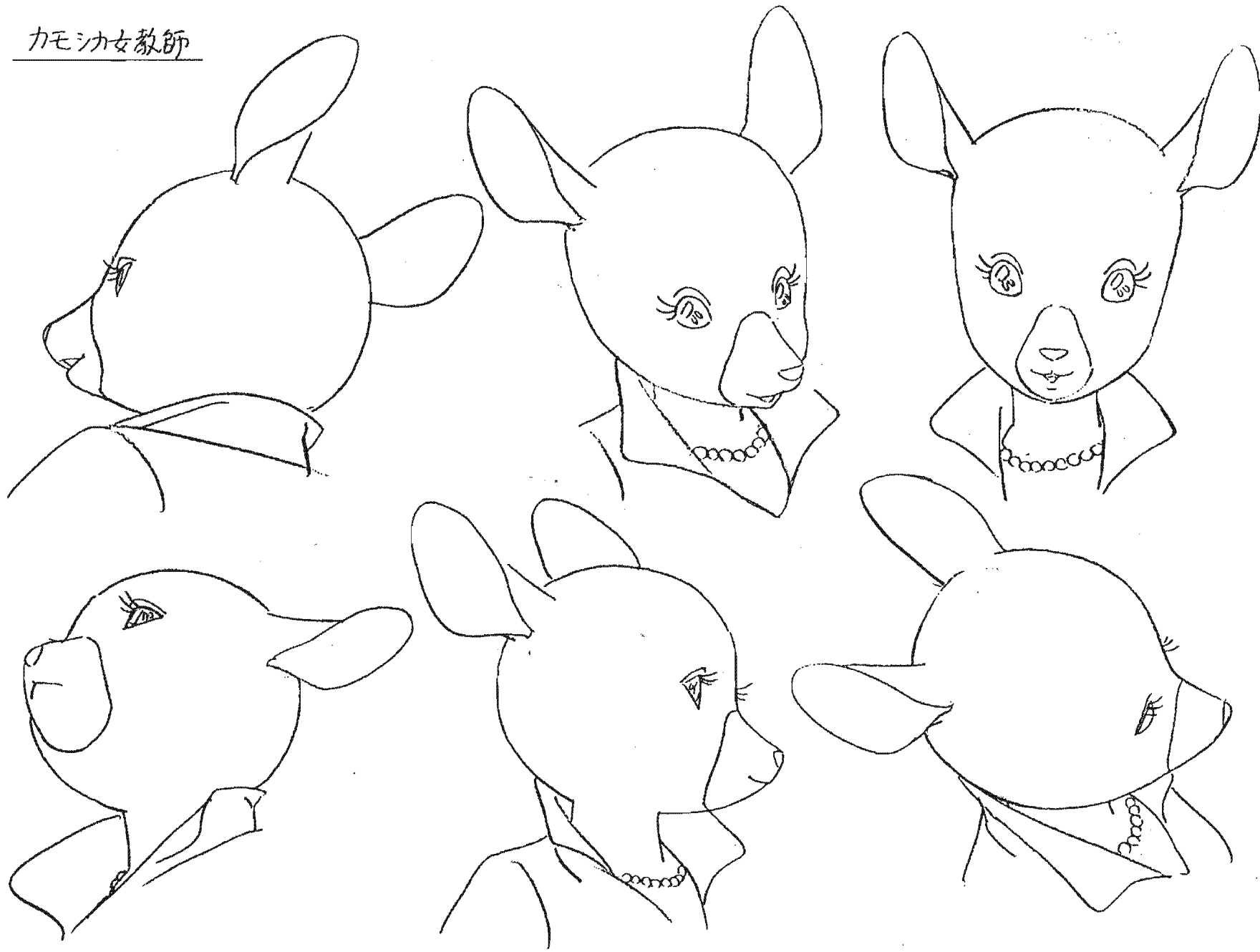

ロバート・ゴルドン

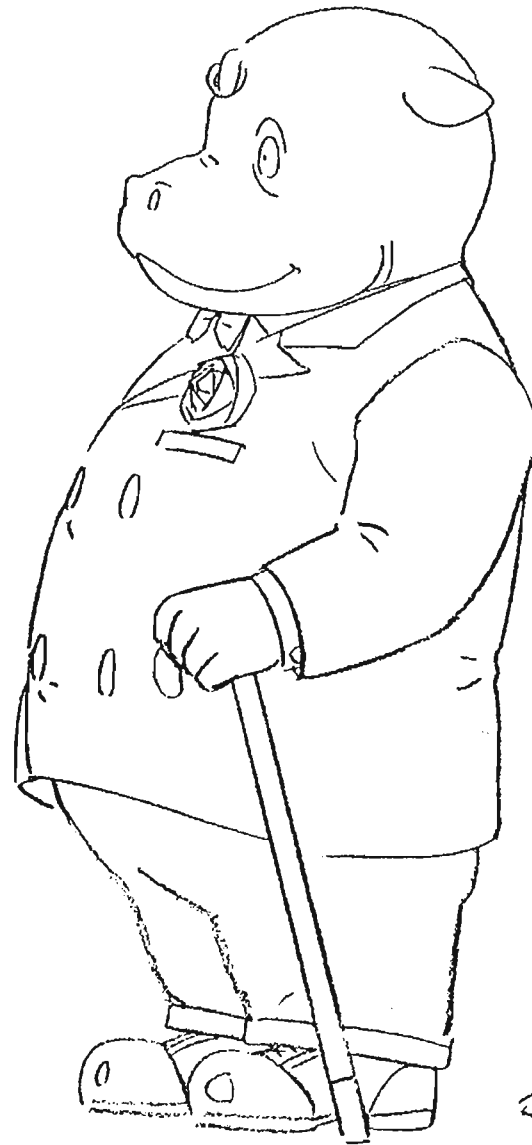
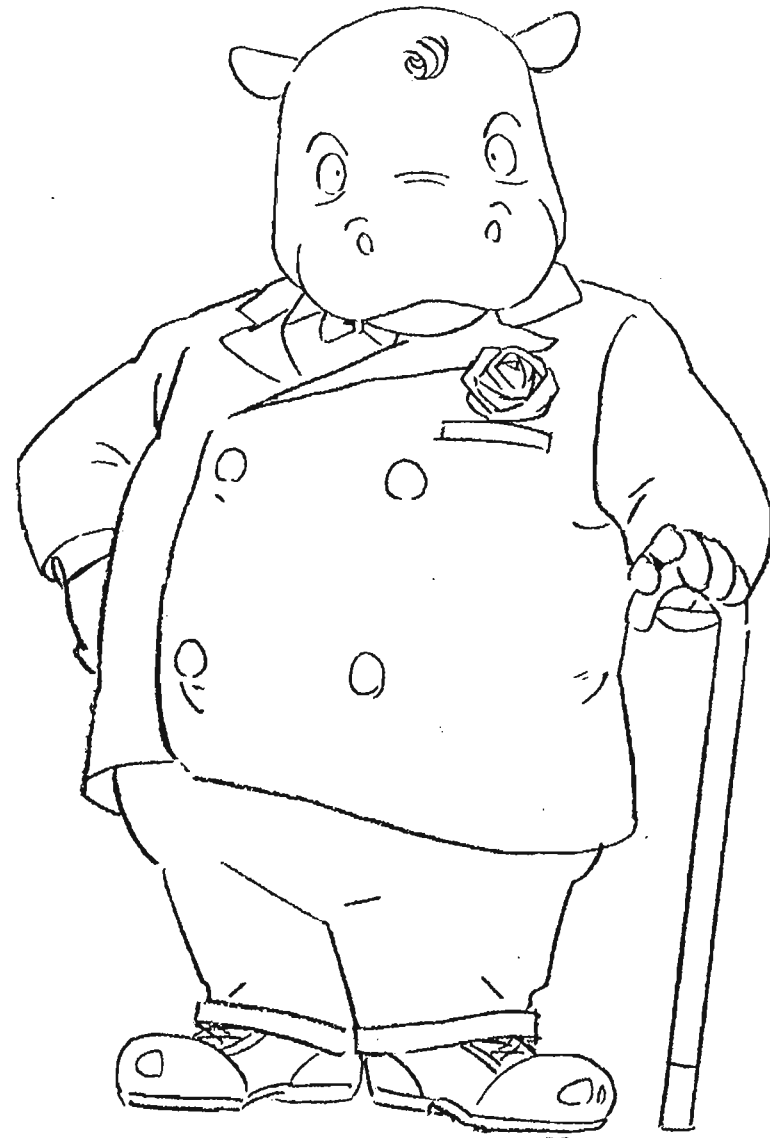

ロバート ゴルデン

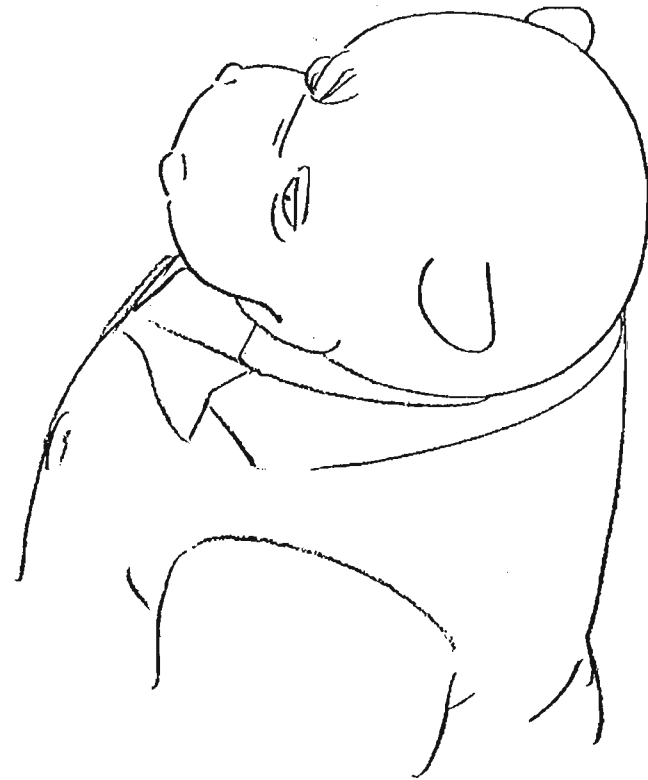

ロバート(コルトン)



灰色グズの工場長

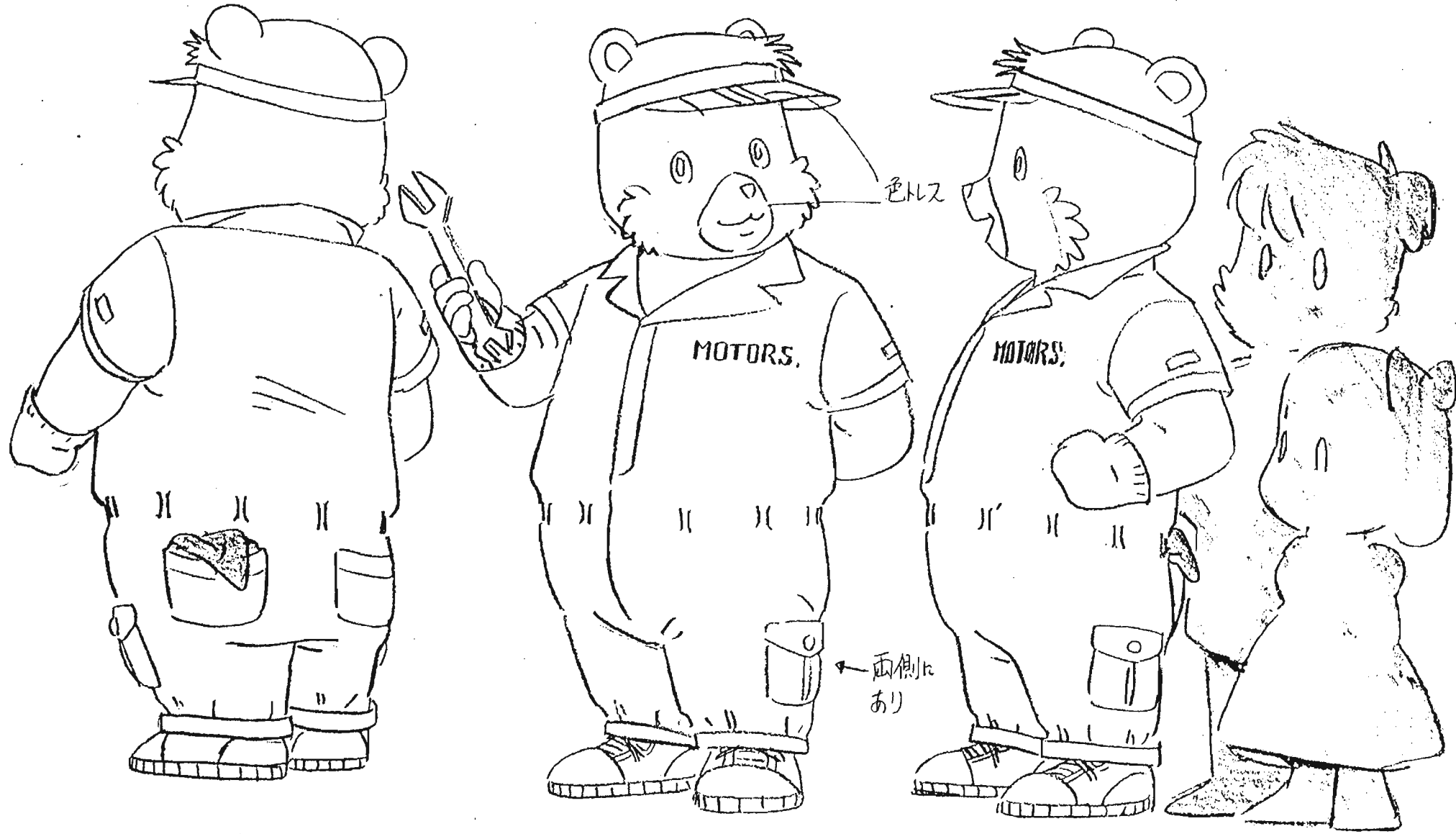

灰色クマ 工場長



ラリー・
ファンダース

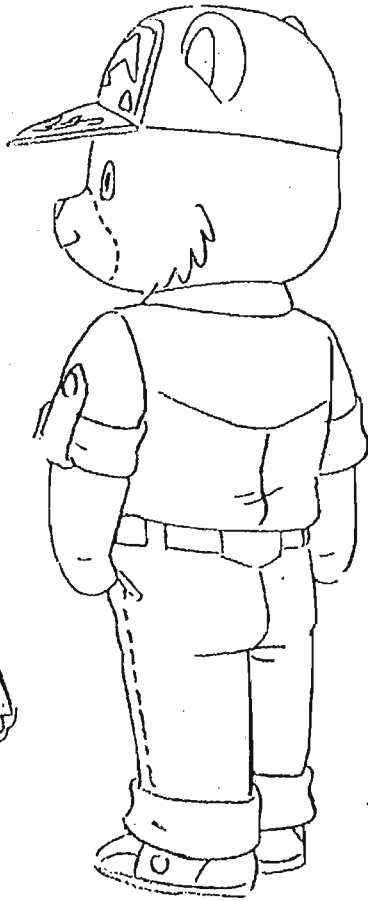
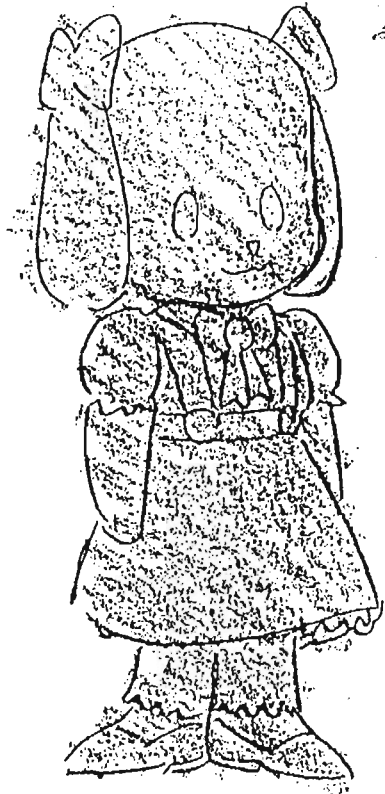

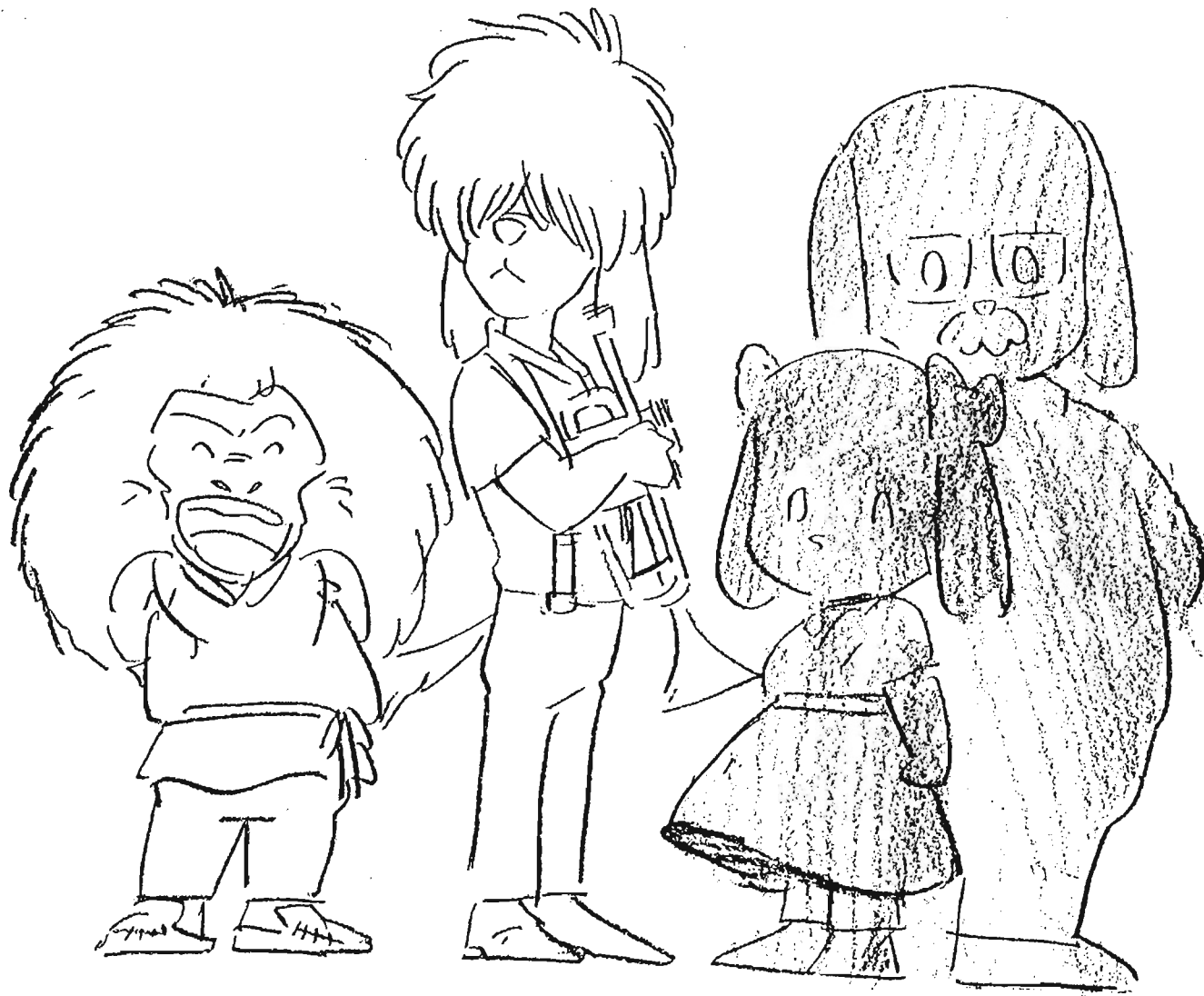

ペカッ

ザワ-グナー

ペカッ



ペカン

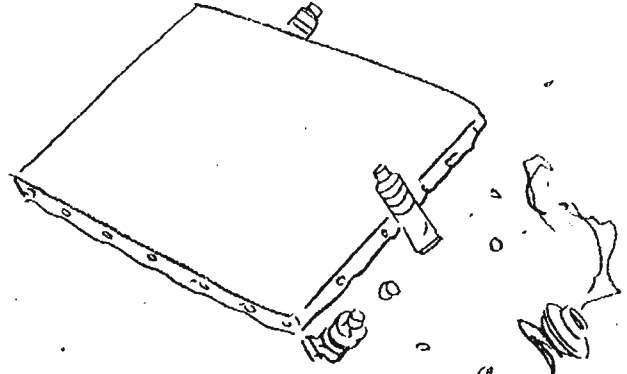

サワークナー

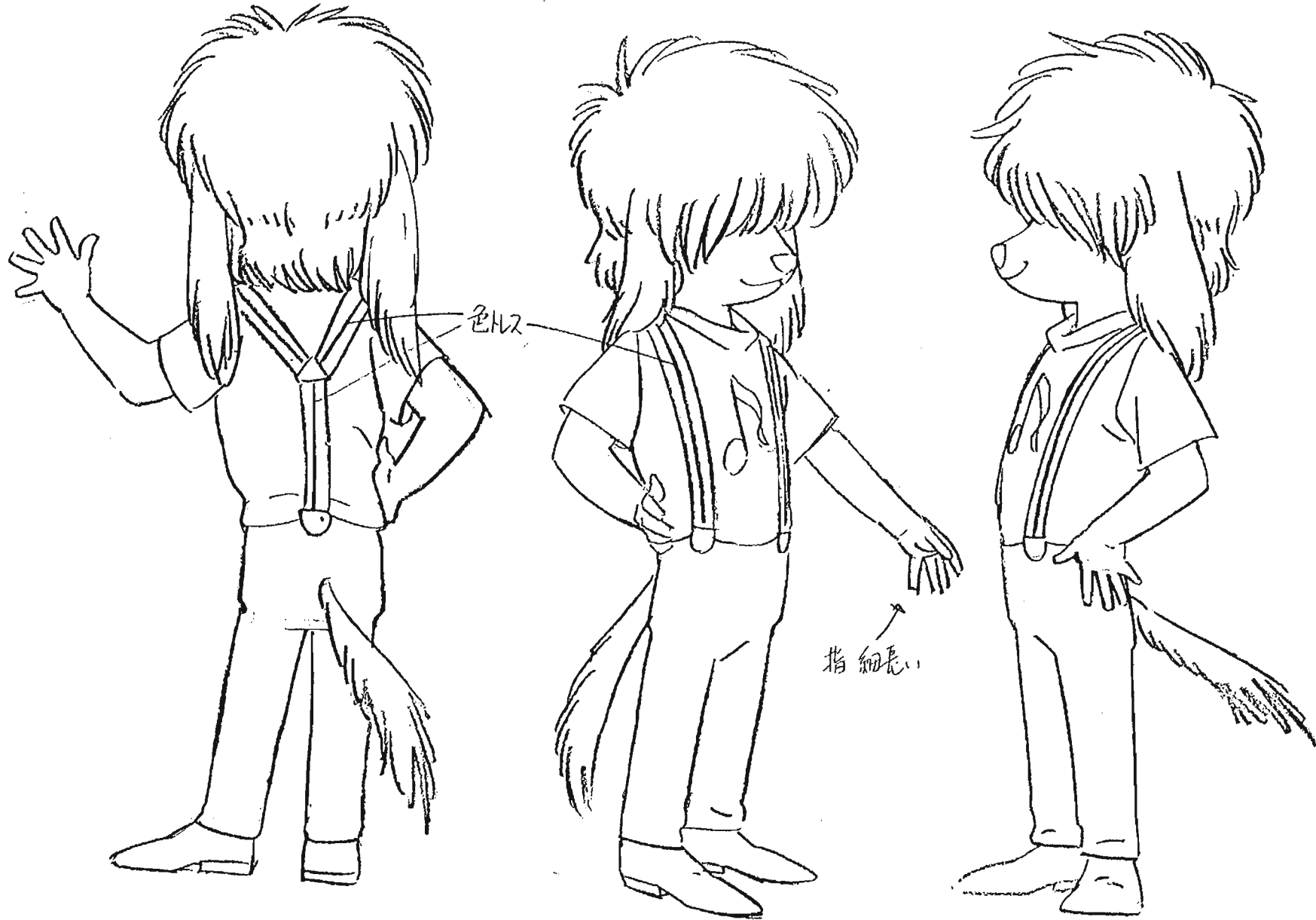

色ムス

指細長い

サーグナー

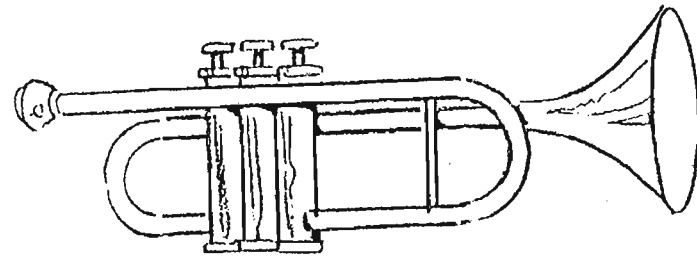

サワグナー

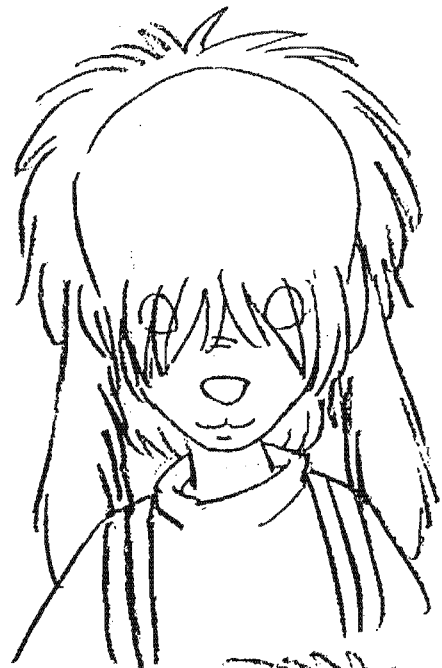

普段は目はみえてません。



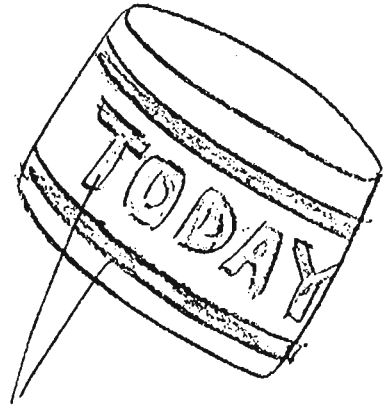

アップのときは
黒でフチドリ



ムービースタジオマン比較図

ステルバグ監督

悪役スター

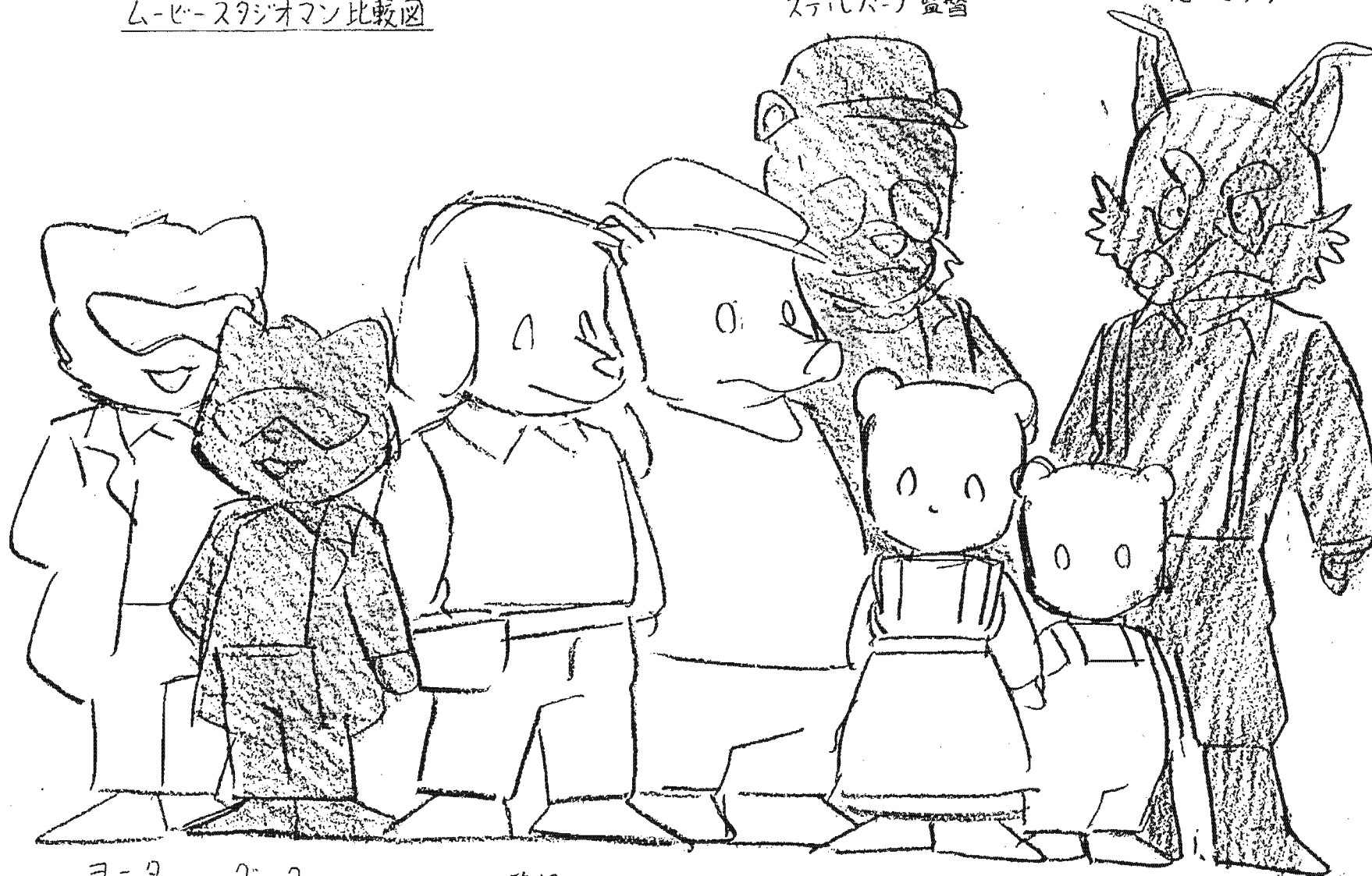

ヨータ

ゴータ

助監督

ムービーカメラマン

シーラ

子役

メイプルタウン物語
南の島のパームタウン

#4

■映画監督 ステルバーグ(ヒョウ) (4)

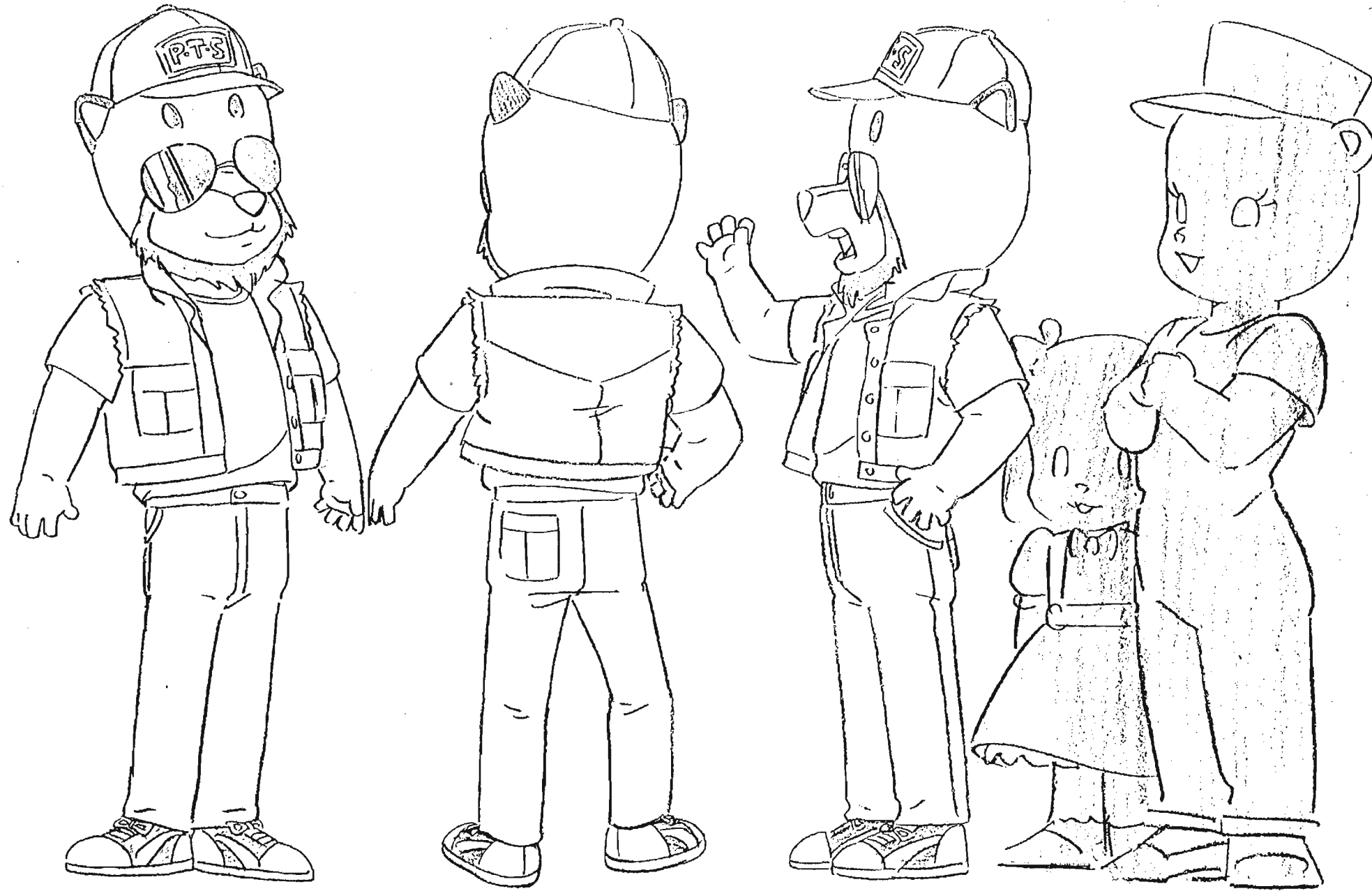



ムービーカメラマン

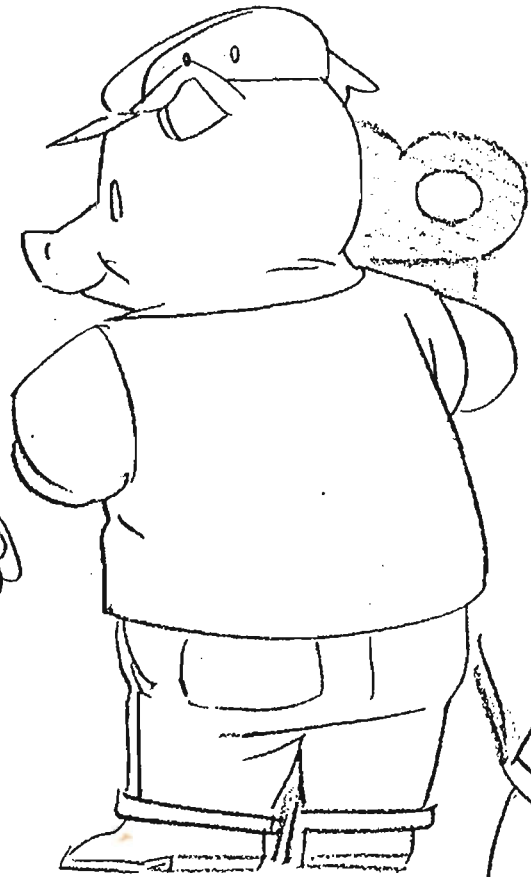

助監督

BA!

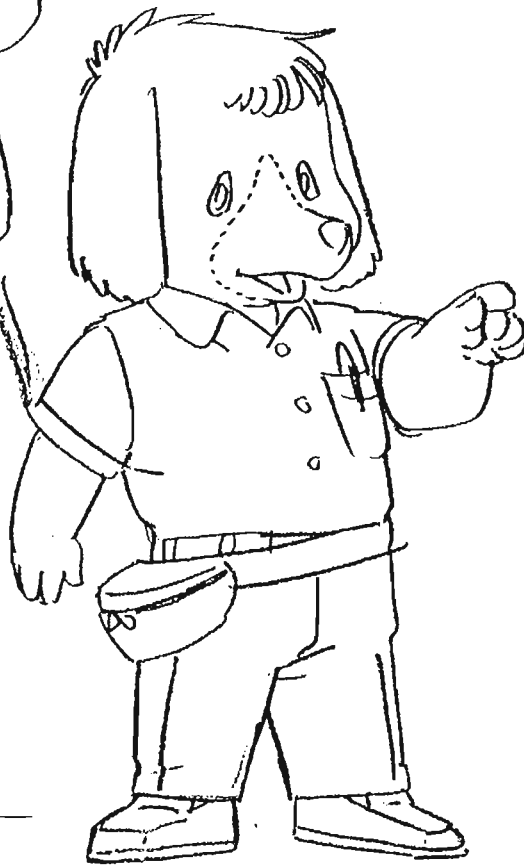

メイプルタウン物語
南の島のバニーガールズ



#4



模様

同色



メイプルタウン物語
南の島のパームタウン
悪役スワ-#4

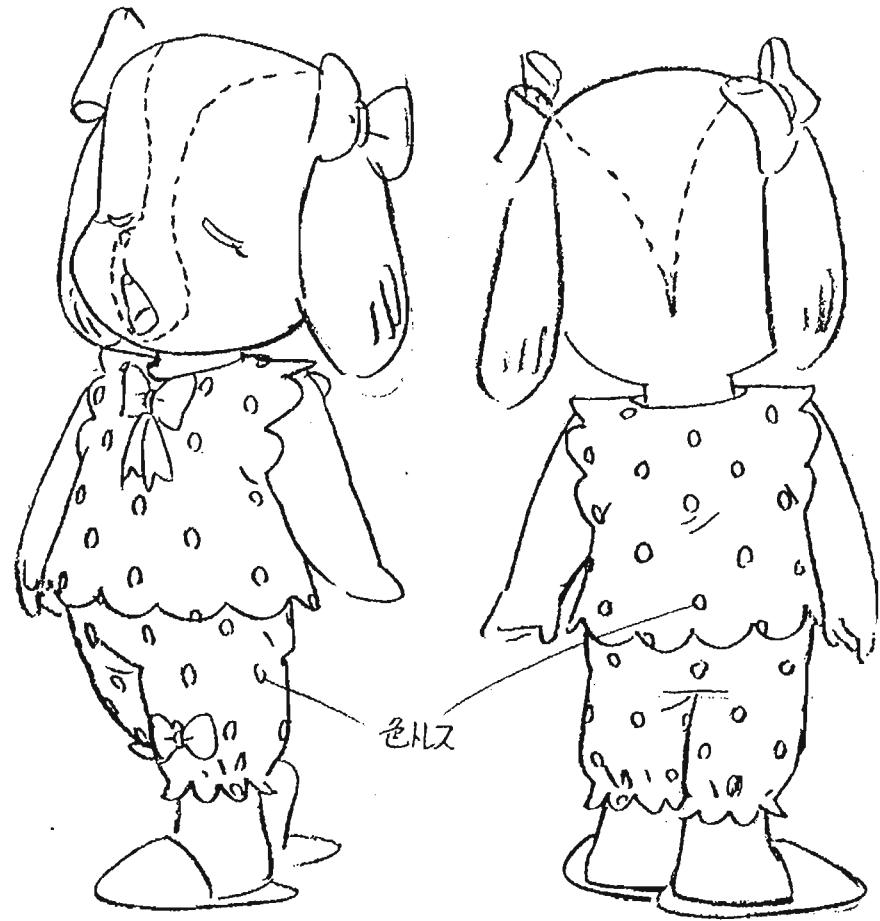

□-リー

ねまき姿 その1

パティ

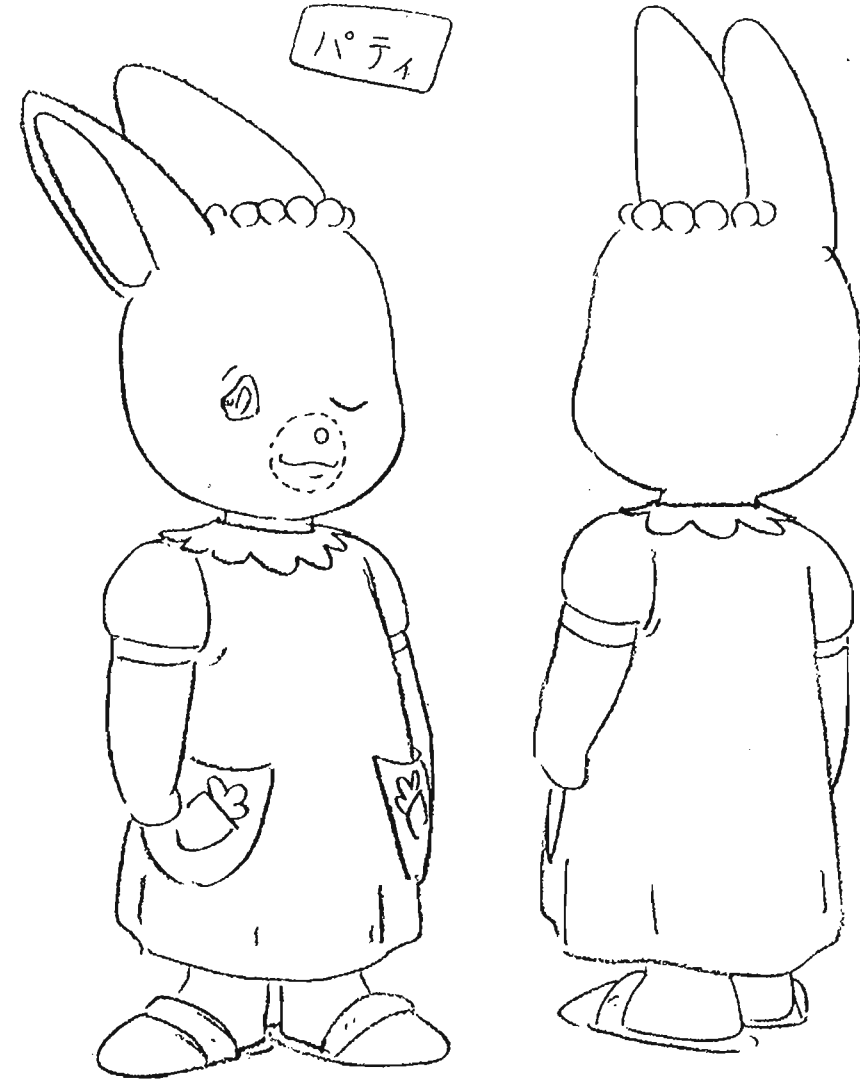

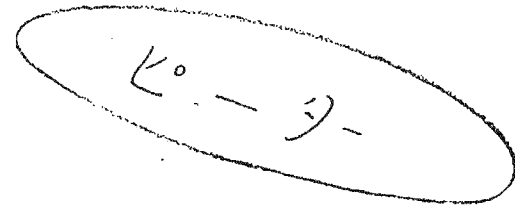
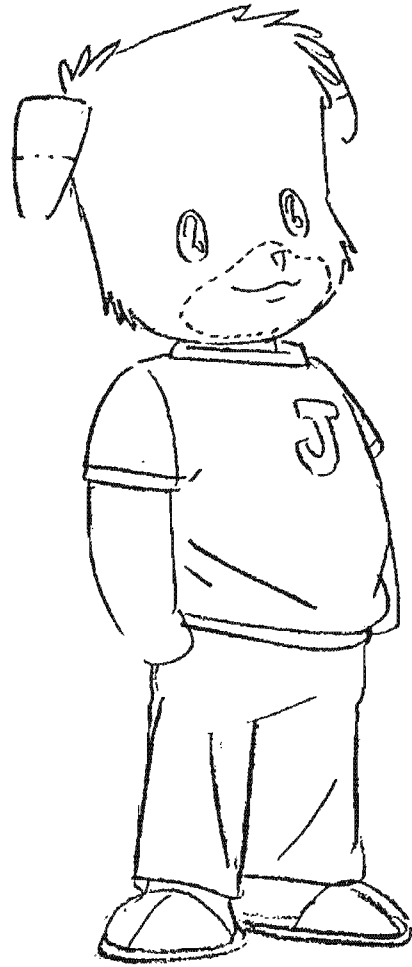

ねまき姿 その2



ラム



ねまき姿の4

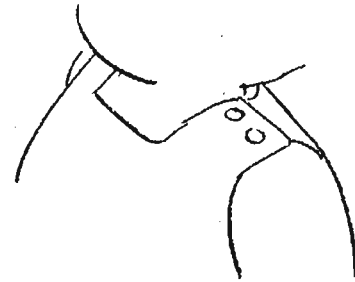

シーラ





□ ジャー



ねまき姿 その3

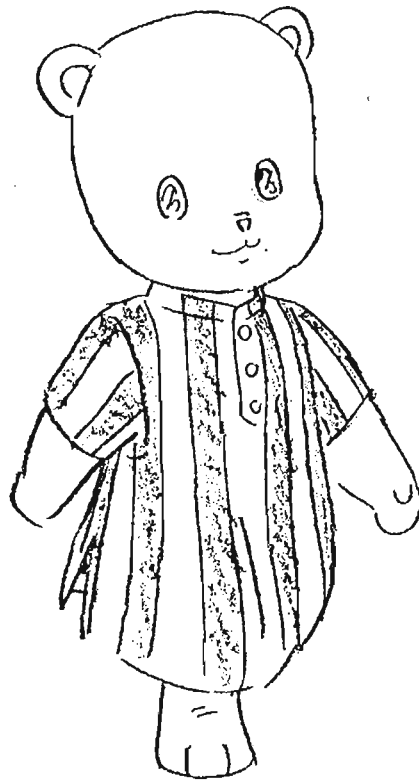

マ-ク

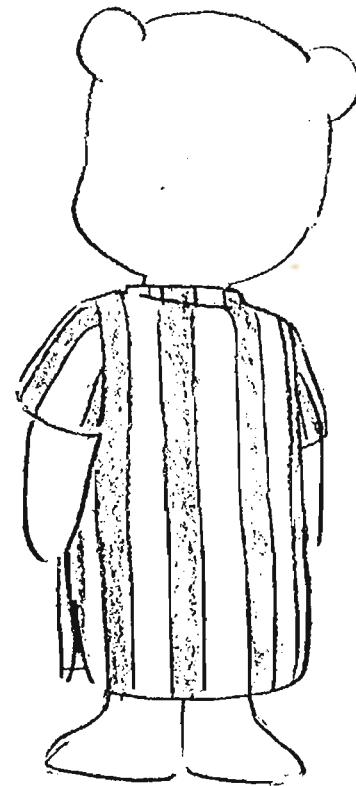

エキストラ (1)

ネコ♂



薄くしと下ま... (フチドリが解るよう)
目の色少し

ミケネコ♂

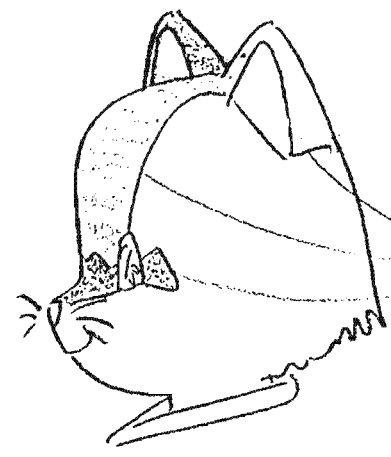

色トレス



色トレス

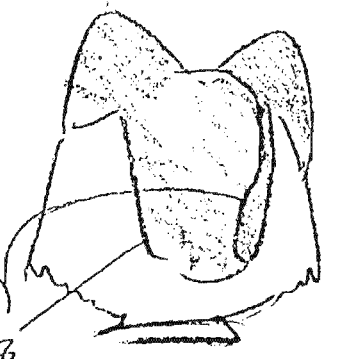

使用可能です。
適当にアレンジしても
エキストラキャラは

エキストラ ②

ブタ♀



アリスジロ♂



グルメシアン♀

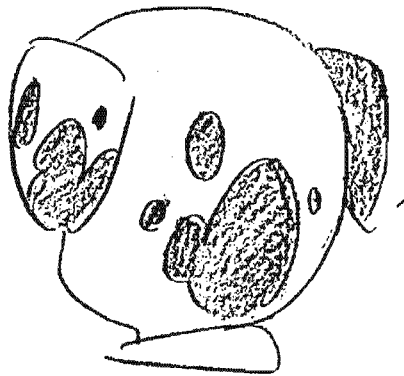
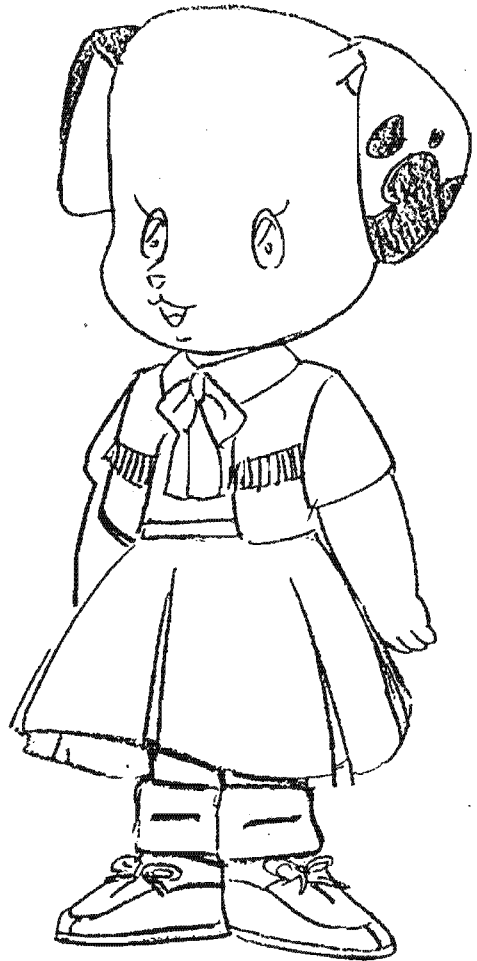

色トレス

色塗り

キツネ♀



実線

色トス

色塗り

色トス

エキストラ

4



チン♂ (チビ)

白・黒に近い
色分け



ゴリテ♂
(ノッポ)

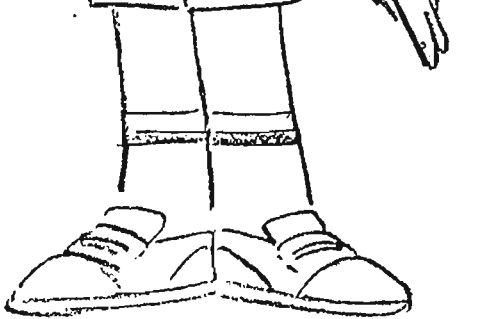

エキストラ ⑤

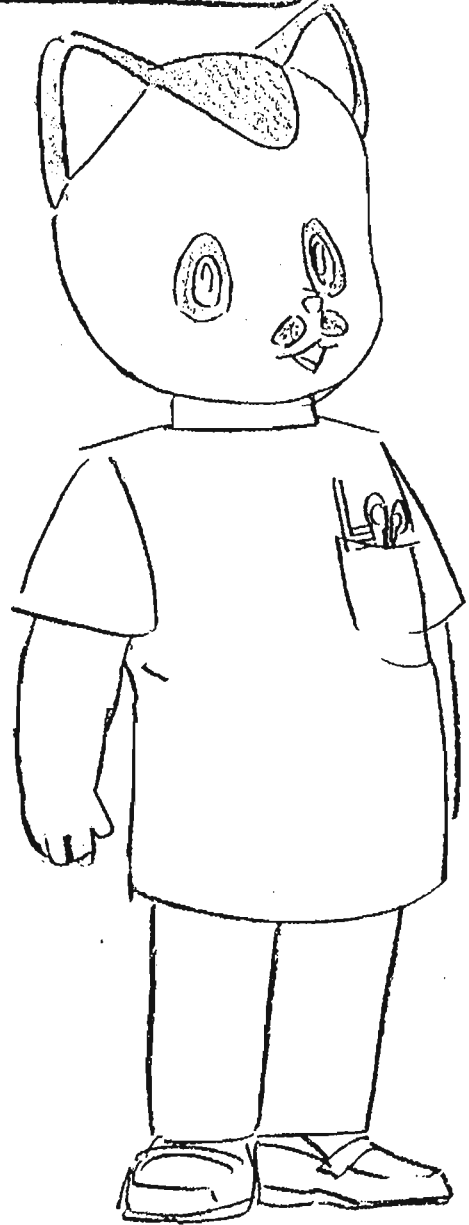

エキストラ

6

カラカル♀

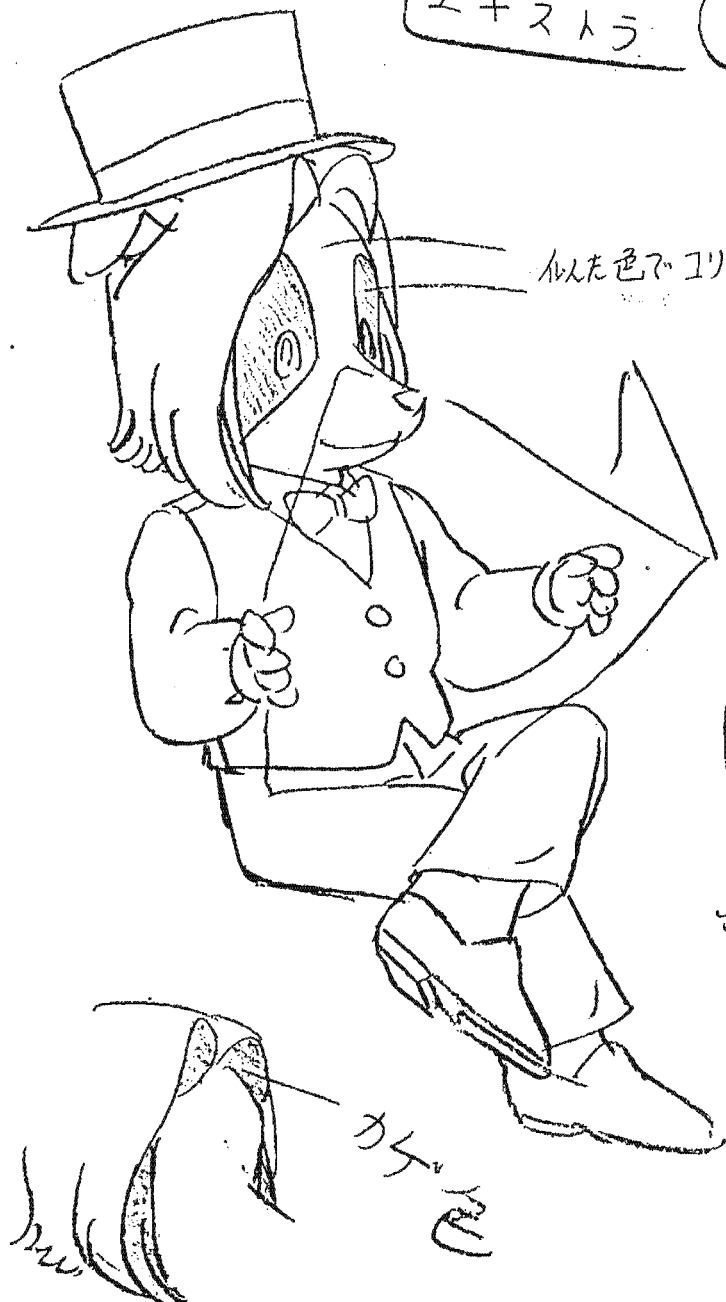

似た色でゴリ♂



色トス

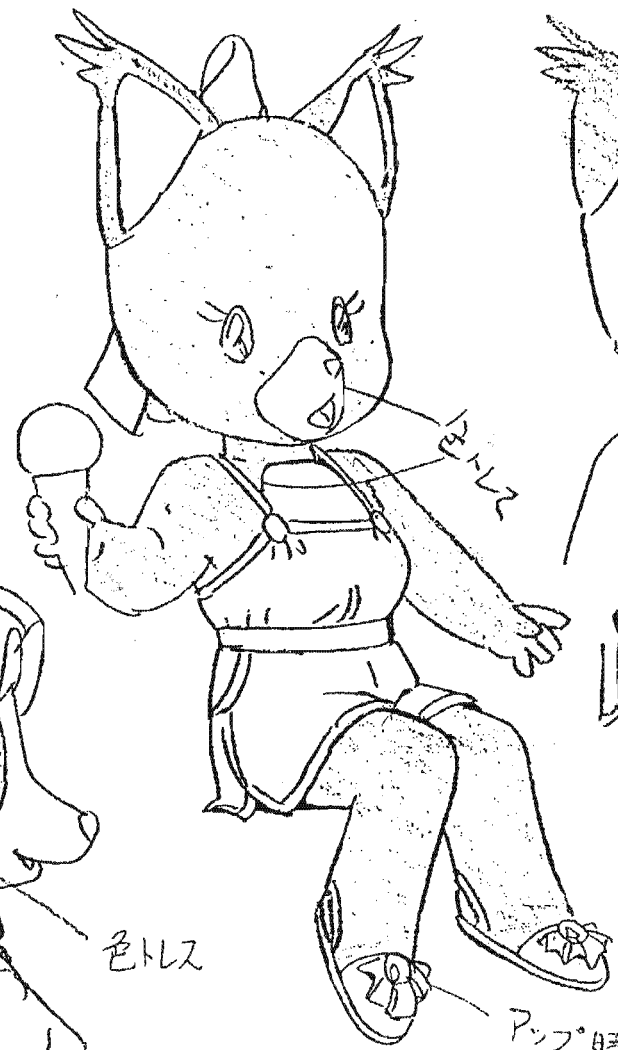

色トス

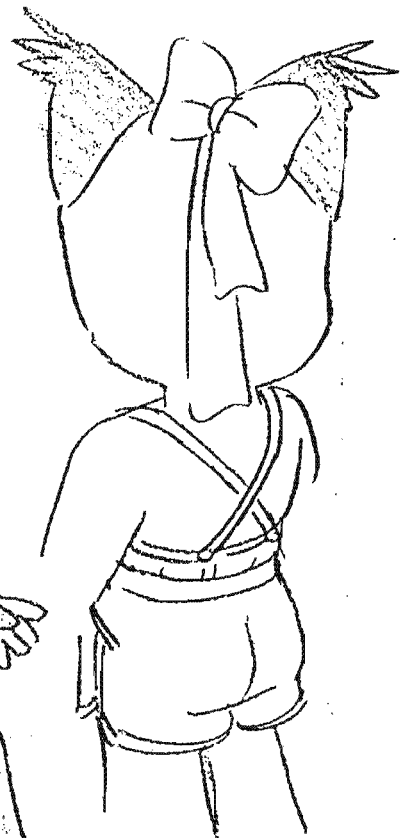

ポンプ時ハイタイムスリ
色トス



カケ

メイプルタウン物語
南の国のパームタウン

エキストラ ⑦

ワニ♂

指先しぼって
いますがシャーフに
しないで下さい。



エキストラ

8

ヒツジ♀

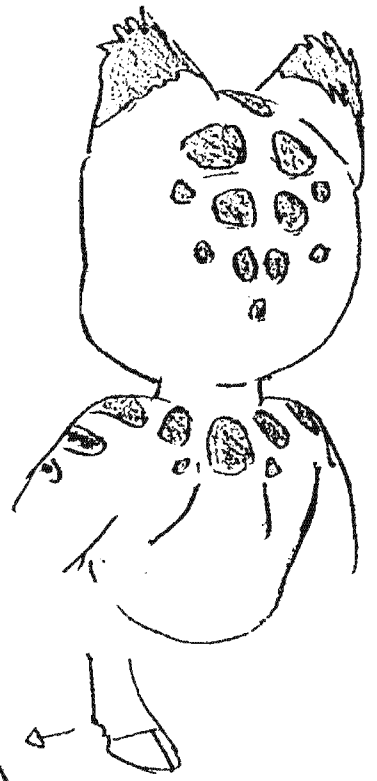
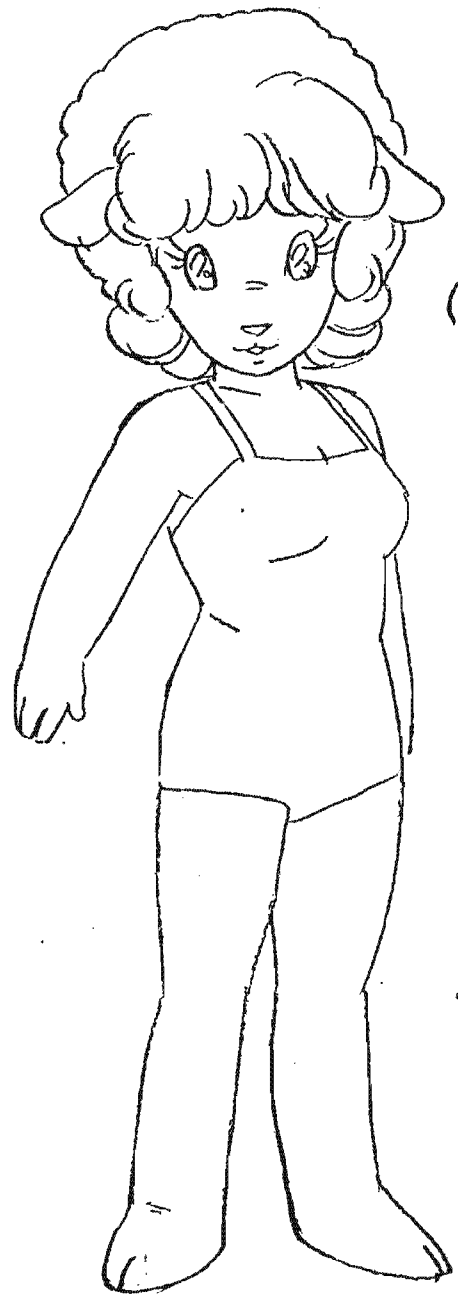

ヒョウ♀

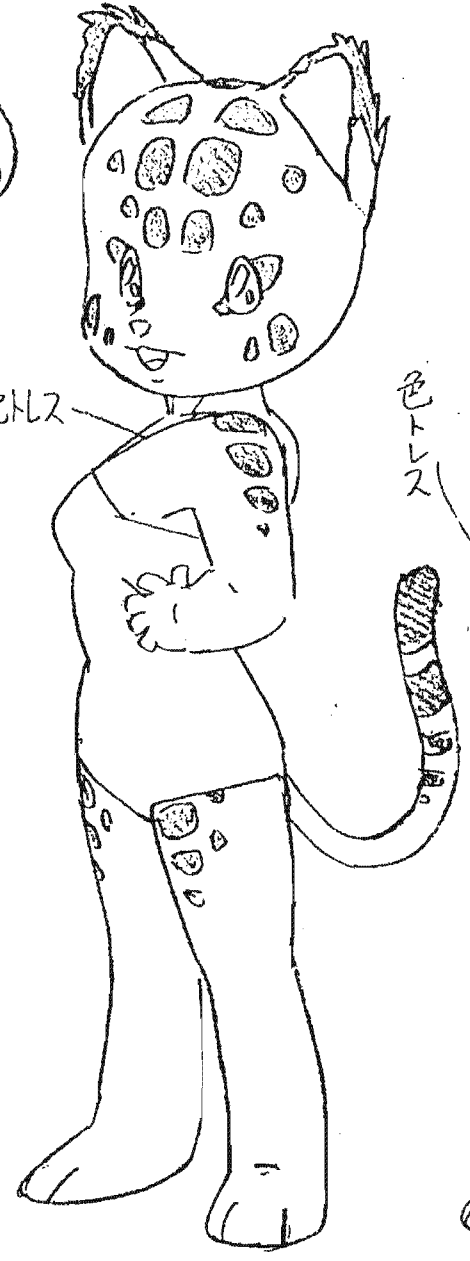

シムネコ♀

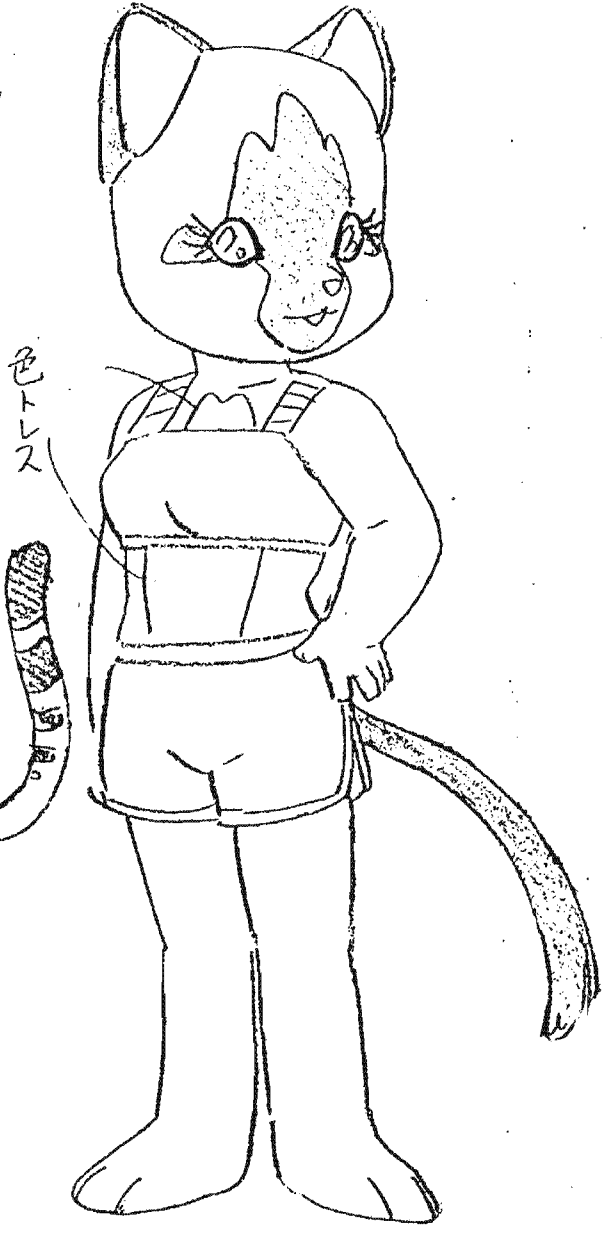

エキストラ | ⑧

ラマ子
(ラマ科?)

カーデガン

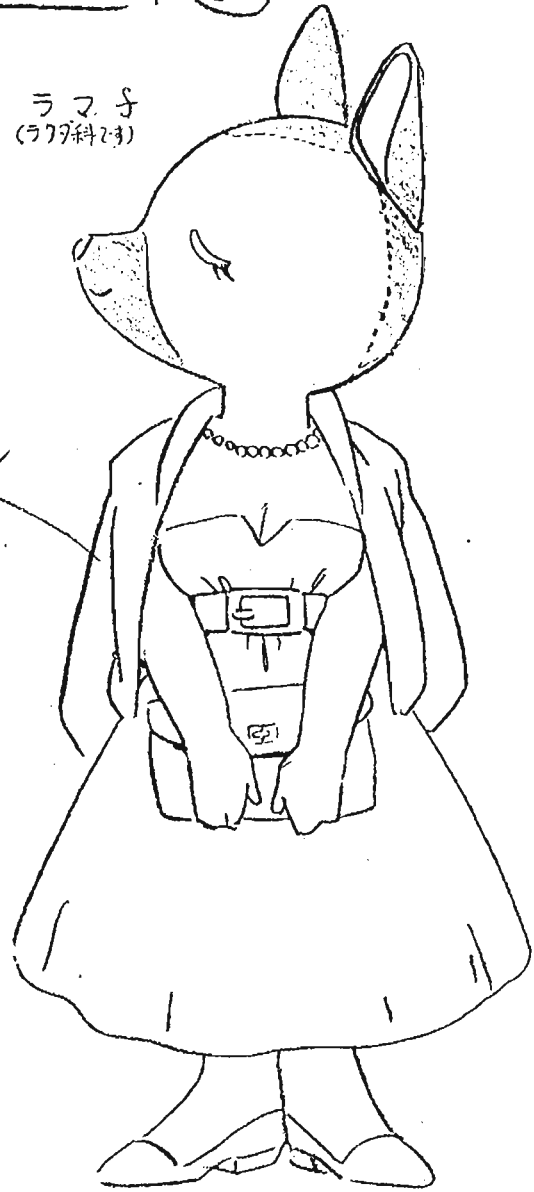

虹彩
(白目では
ありません)

ネコ子



肌

ヒツジ子



ジーンズの
スカート

メイプルタウン物語
南の島のマーメイド

ヒツジ子



コリー子

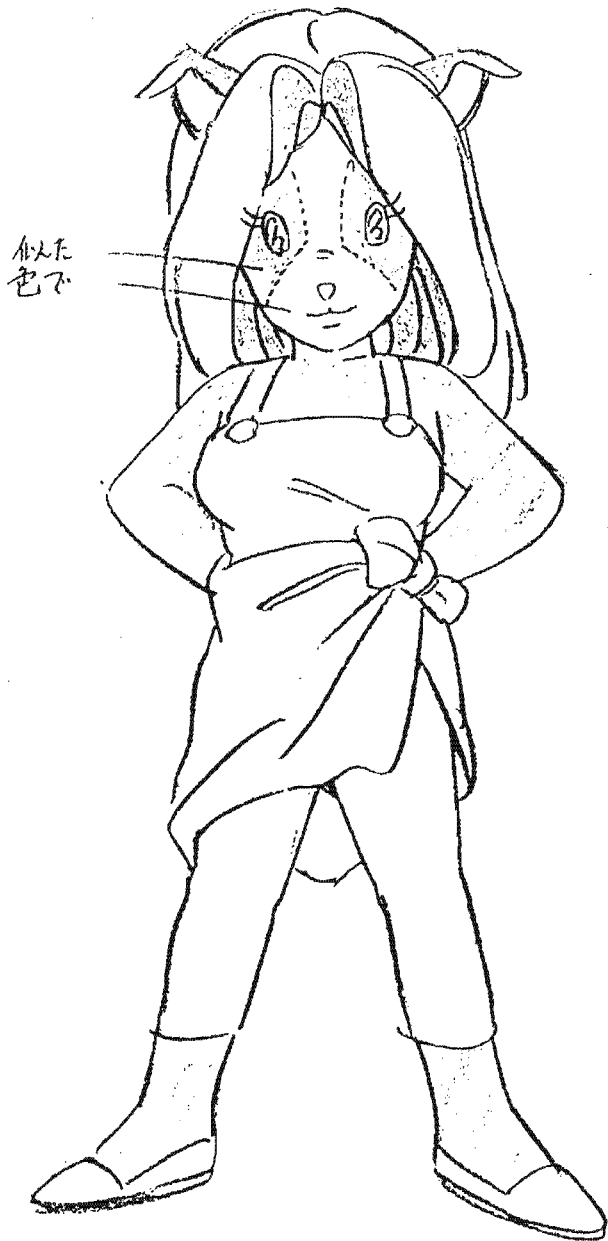

ウサギ・タッチ種子

ウサギ・ヒムラヤン種子

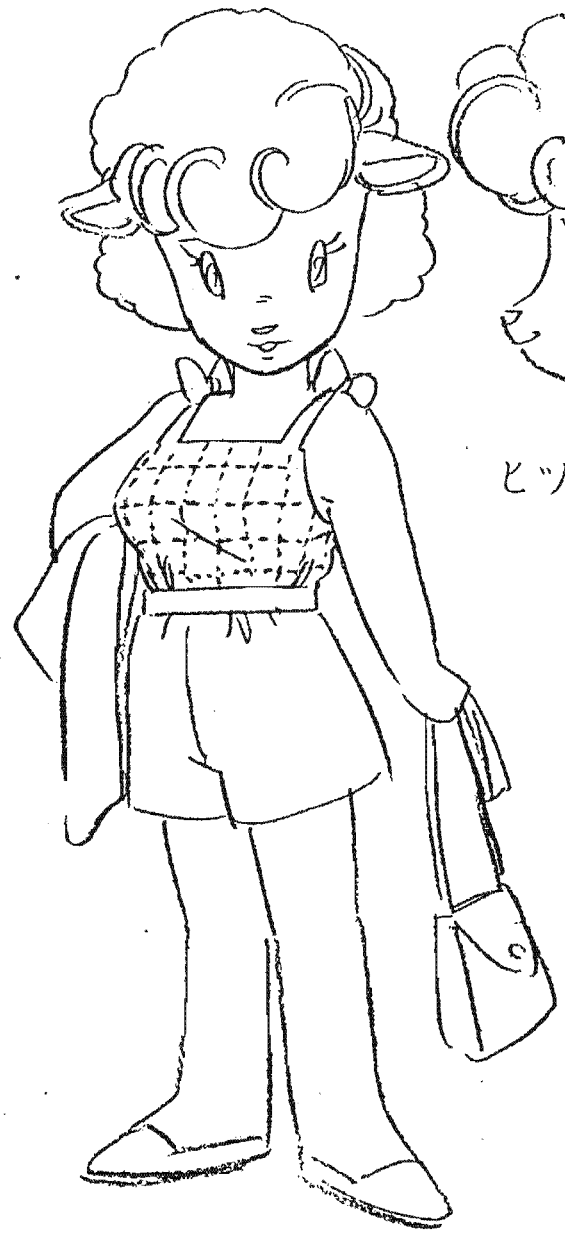

ヒツジ♀



同色

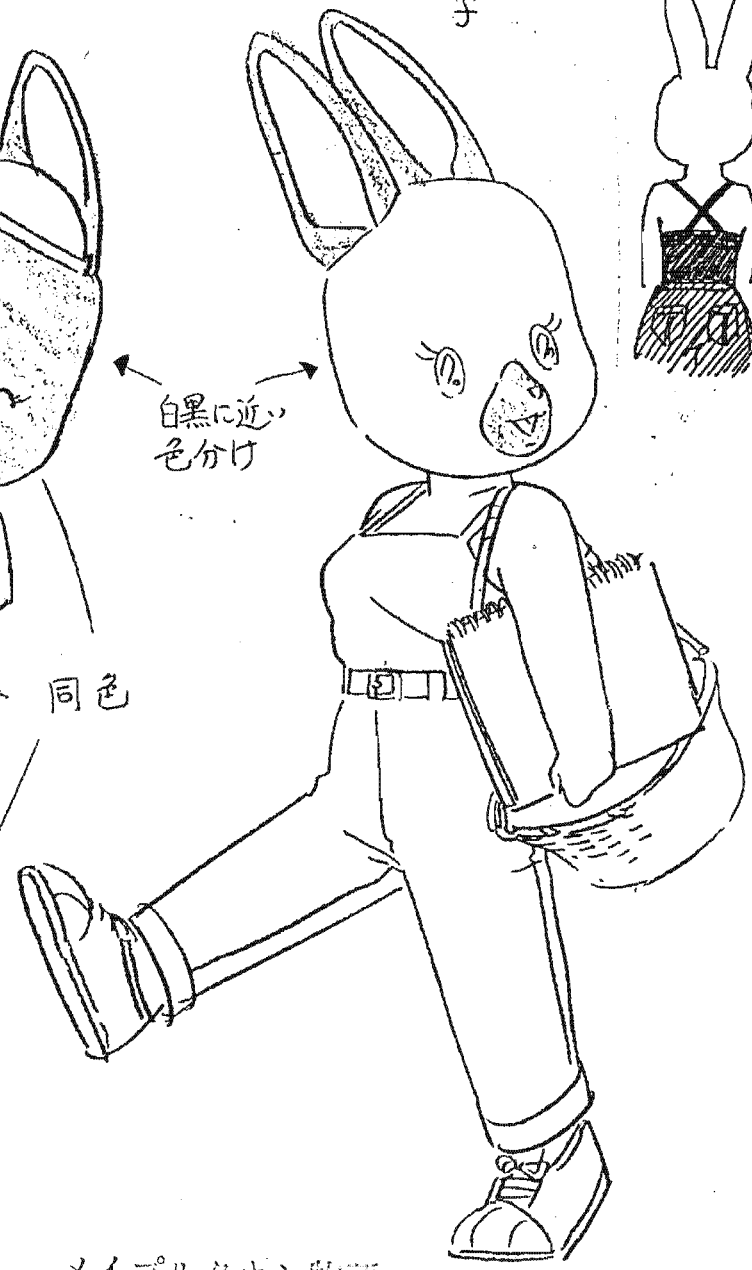

白黒に近い色分け

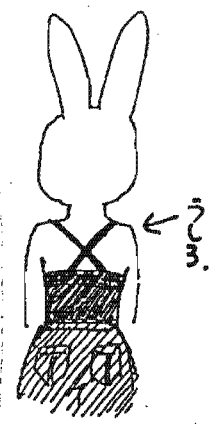

うさぎ

メイプルタウン物語
南の島のパームタウン

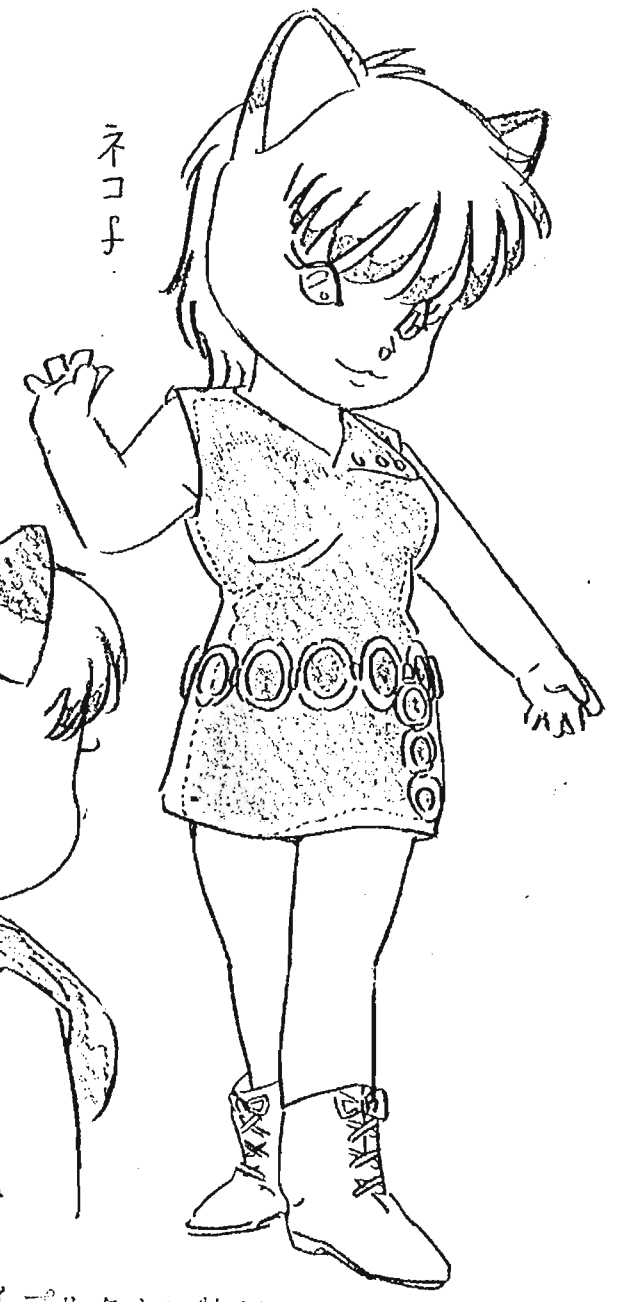
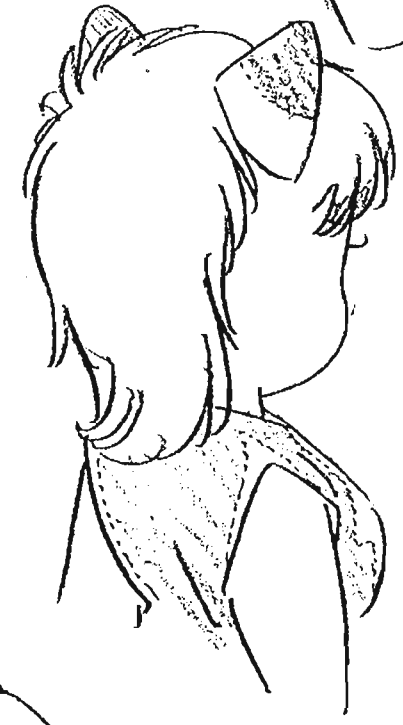

メイプルタウン物語
南の国のパームタウン

エキストラ 12

クマ♀



イヌ♀



ポートル♀



エキストラ 13

12♀

12♀

ウサギ
アンゴラ
♀

裏線

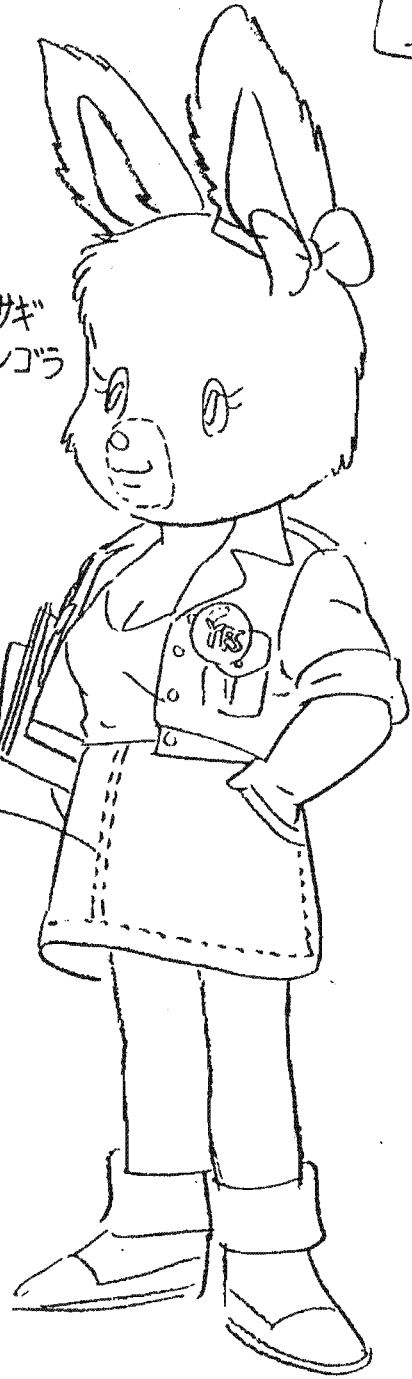

ドーマルマン
♂ 刑事

エキストラ

14

ホクサー
ホリス
♂

ドーマルマン
♂
フは
黒い
毛

黒
茶
（実物参照）



リス♂



エキストラ ⑮



トムソングセル

♂



エキストラ ⑩

ホイボット
(イヌ)♂

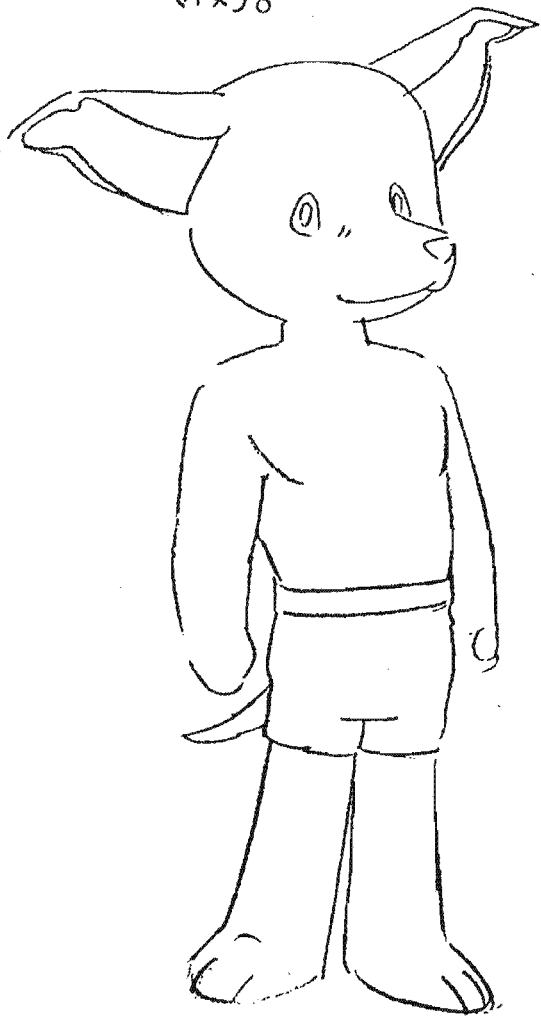

アメリカテン♂



ウシ♂



エキストラ 17

スキャン♀



タヌキ(アライグマ)

キツネ

薄いスカーフ



□-ツィのアイスクリーム

for
LONG

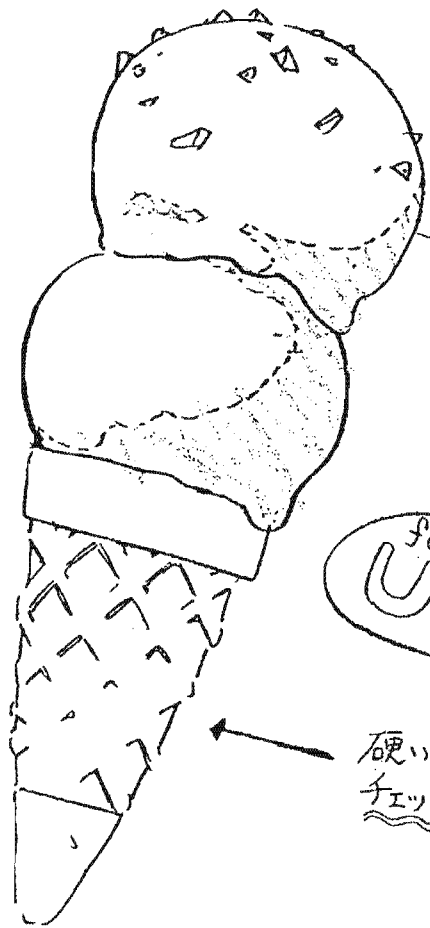

輪郭実線

for
UP

硬い感じになってはうの？
チェック部分的に抜いて下さい

メイプルタウン物語
南の国のパームタウン



シーラ



子役.m

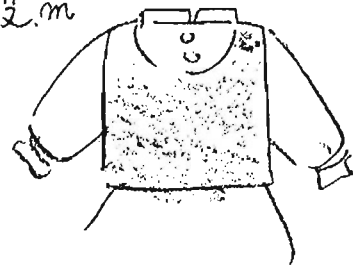

シーラ子役ケスト服#4

メイプルタウン物語
南の国のパームタウン

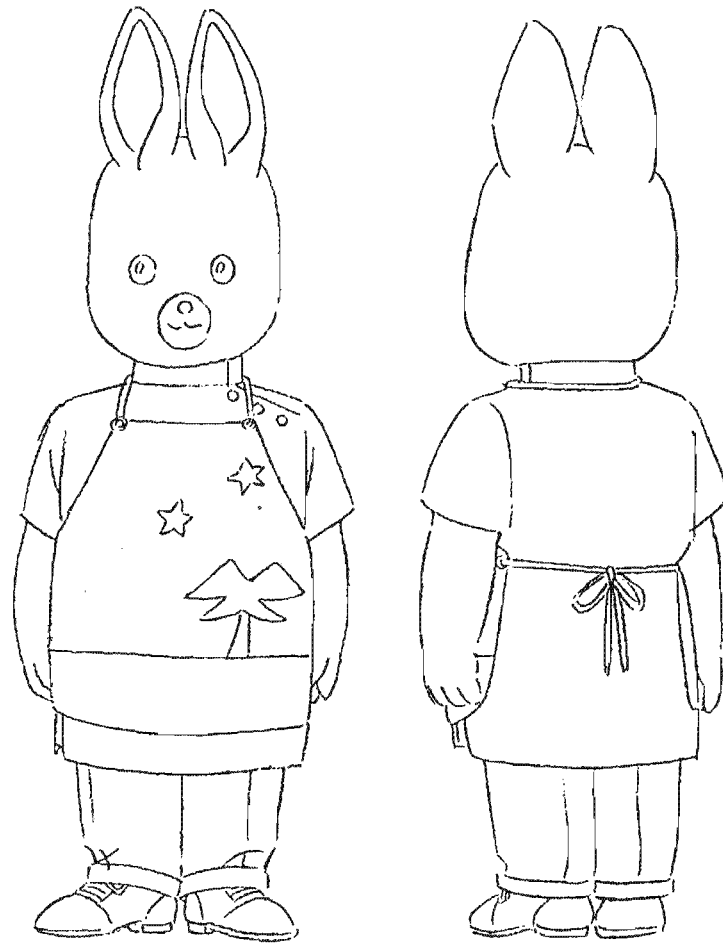

パームタウン#⑥ リョーリのエアロン姿

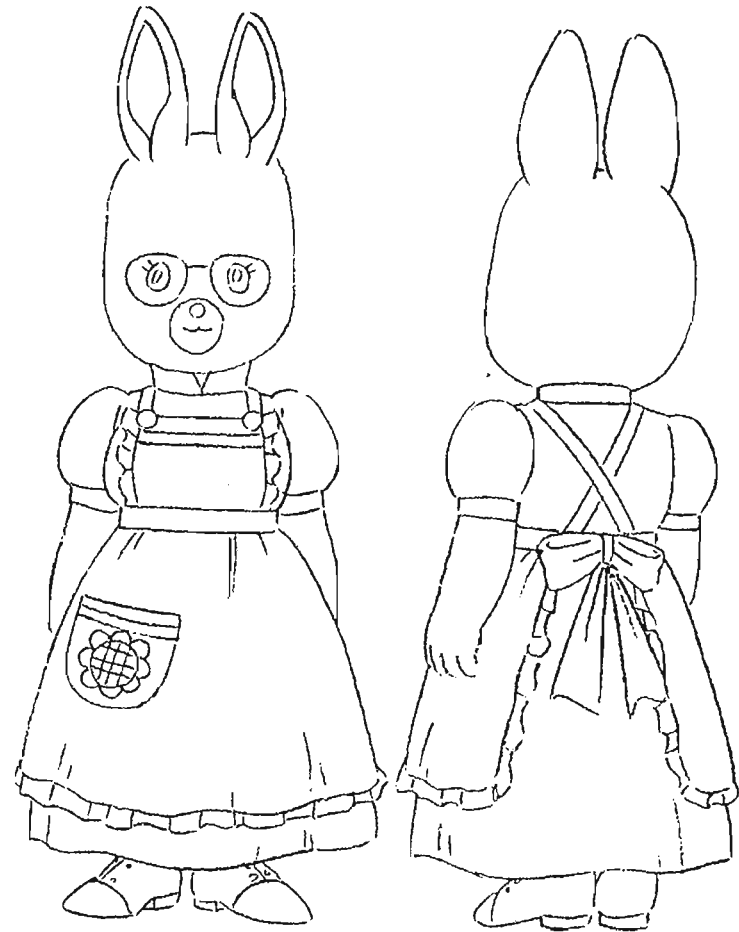

パームタウン#(6)

シェーンの工房の姿

♪



女優

パルシャ子

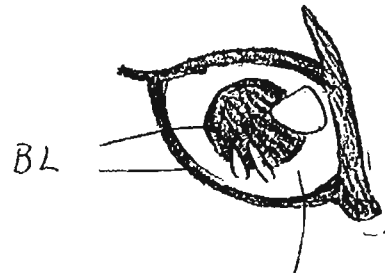

虹彩
(白目ではない)

110-4タウシ4話



船.

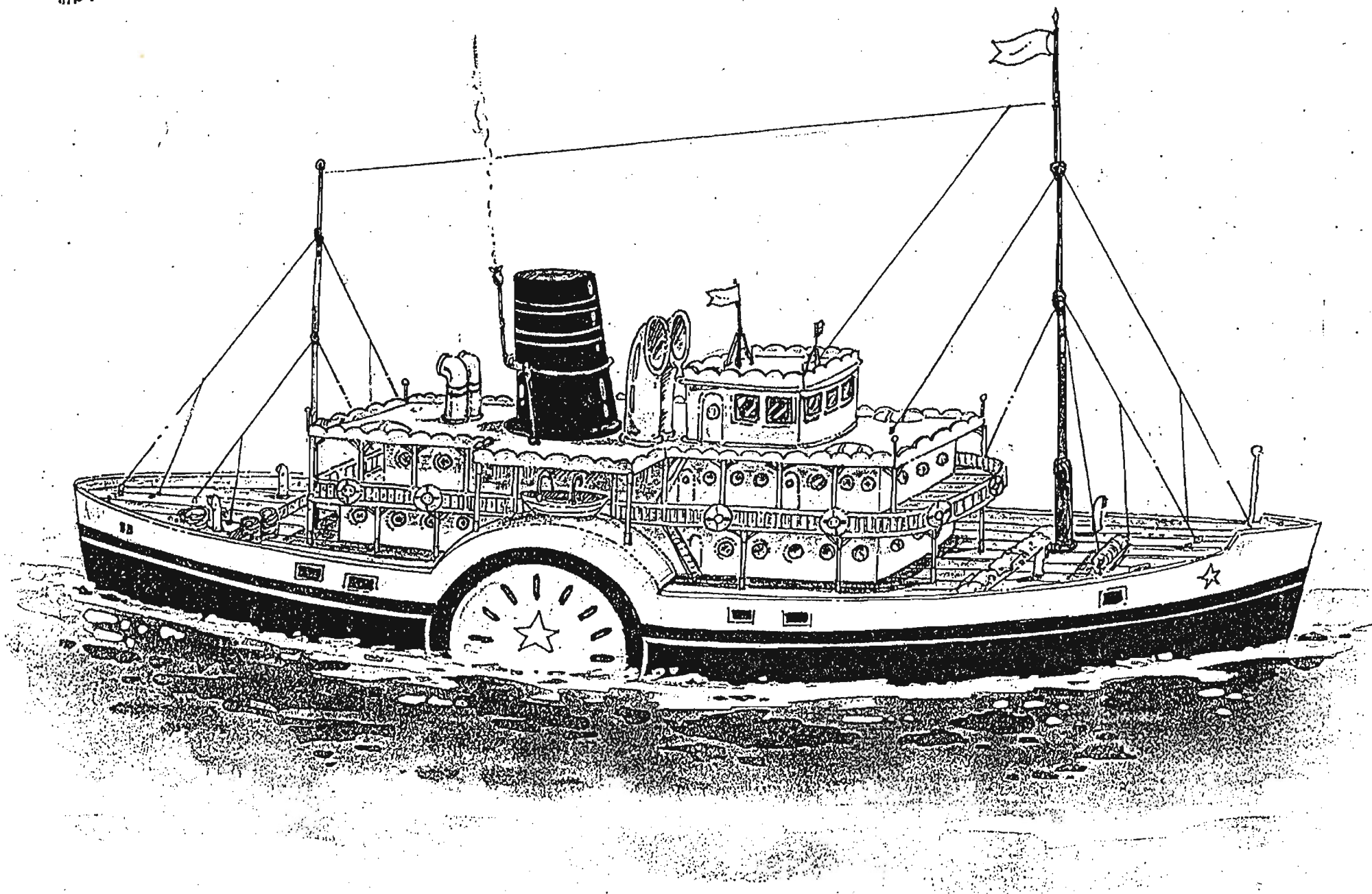

ヨット

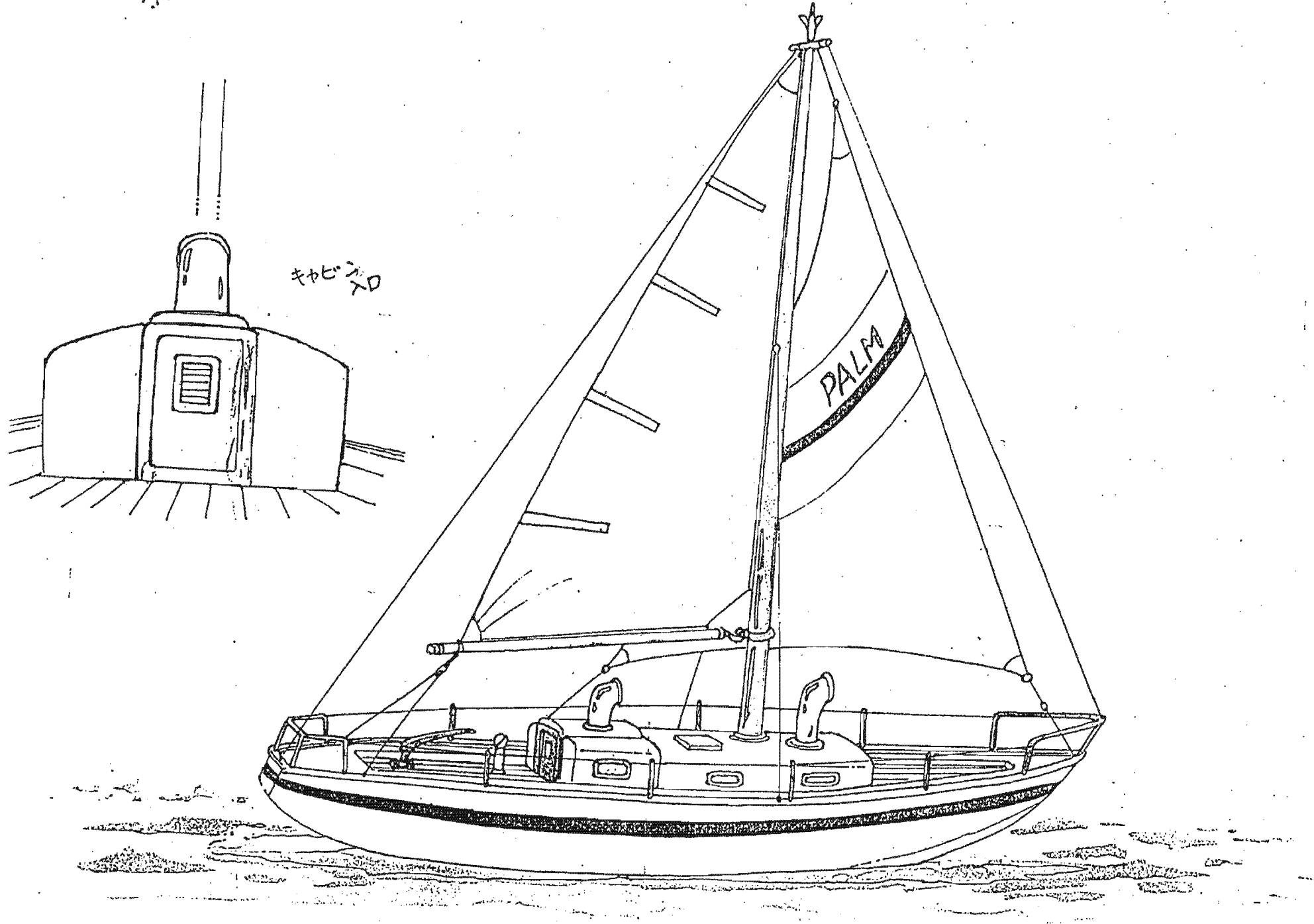

キャビン

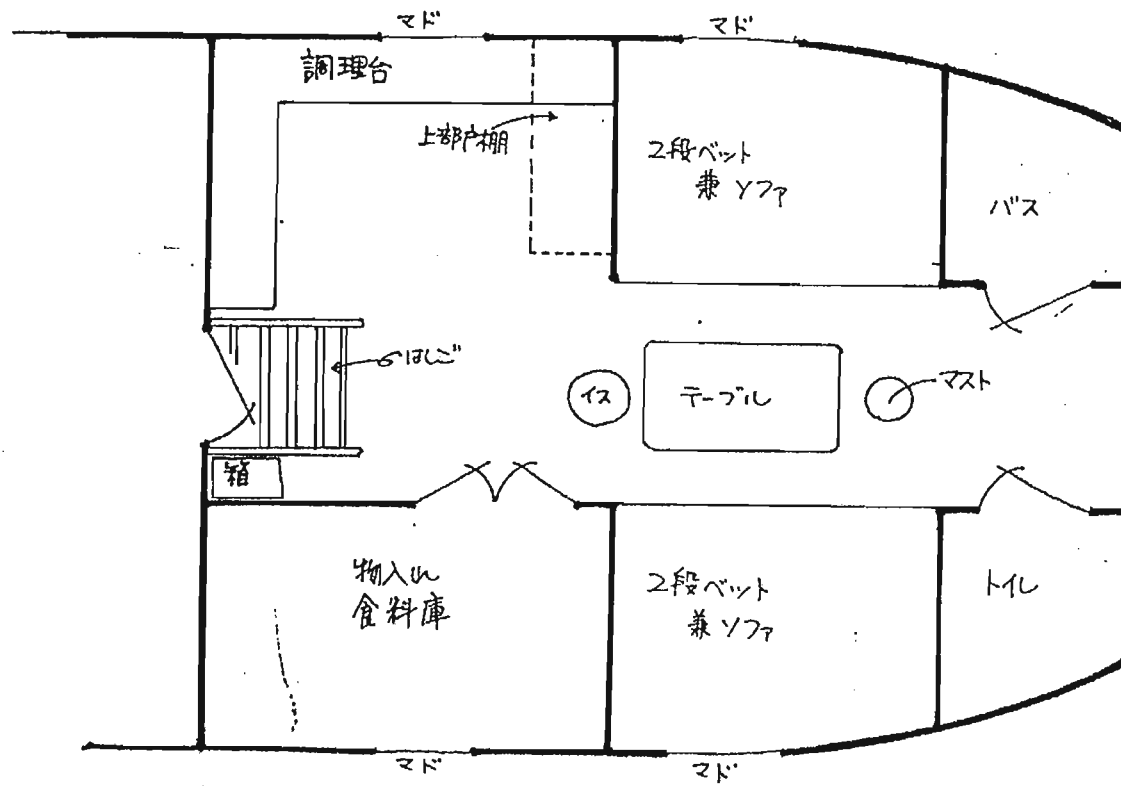

ヨットのキャビン (平面図)

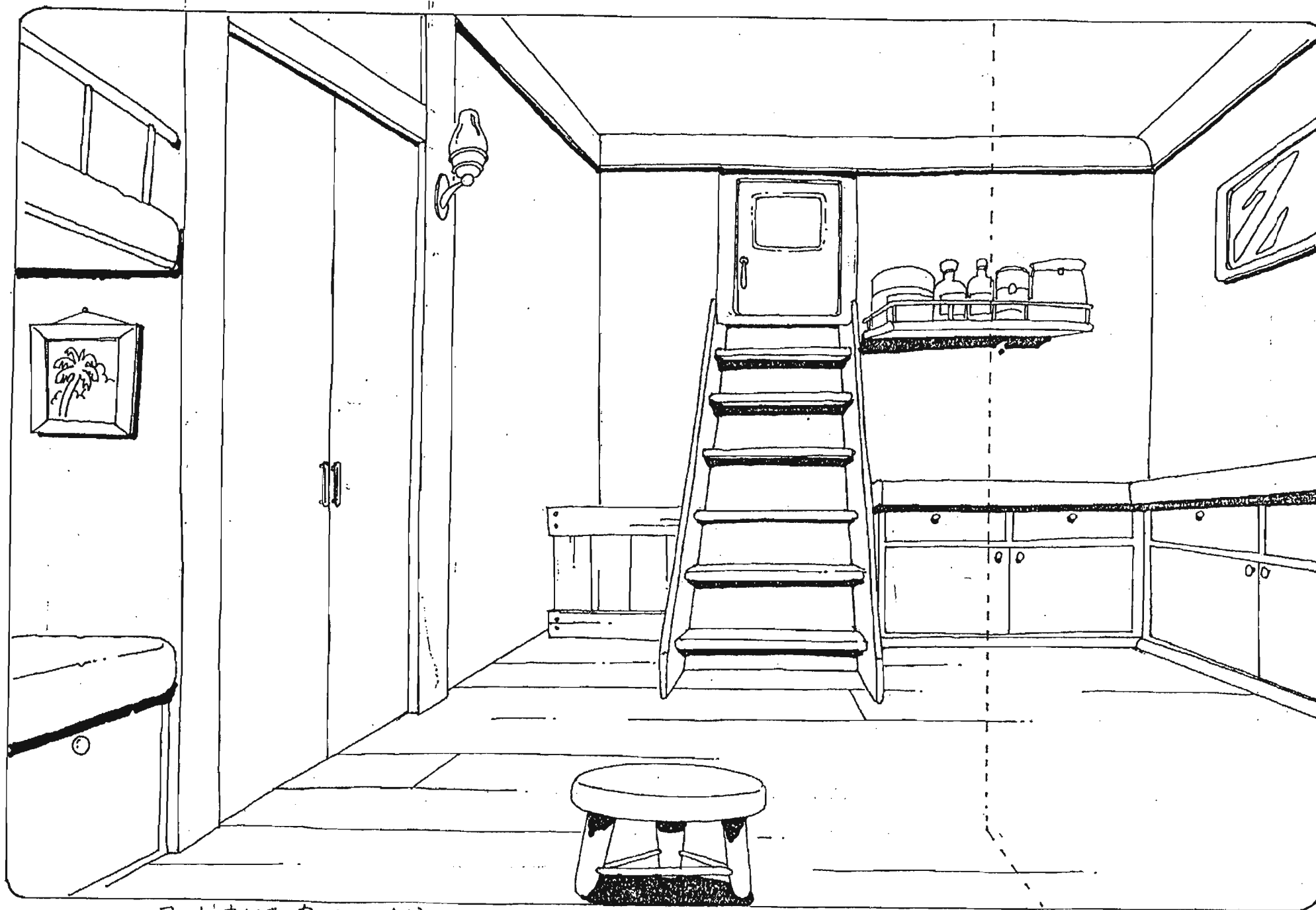

ヨット:キャビン内 (入口側)

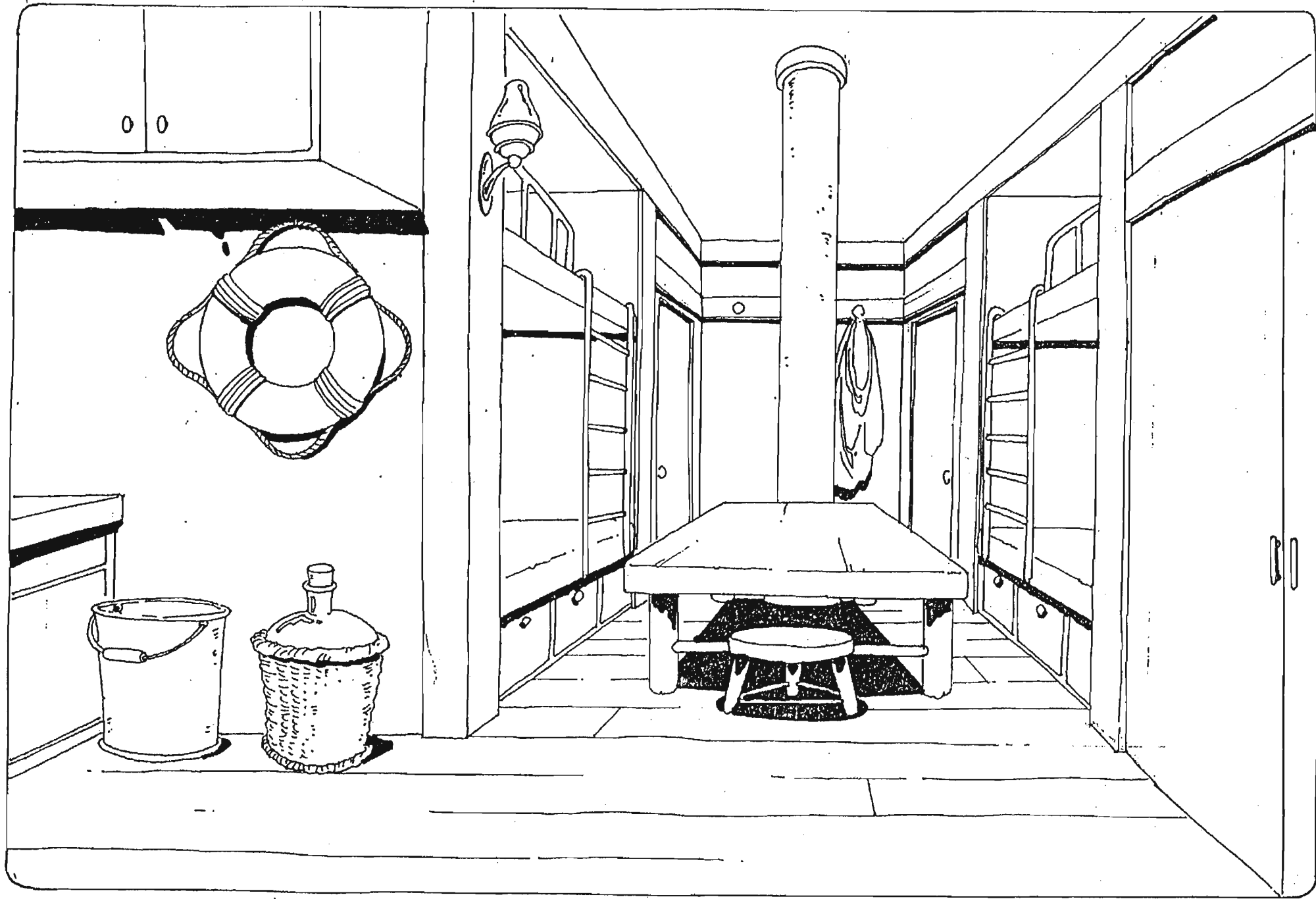

ヨット. キャビン内

モーターボート②

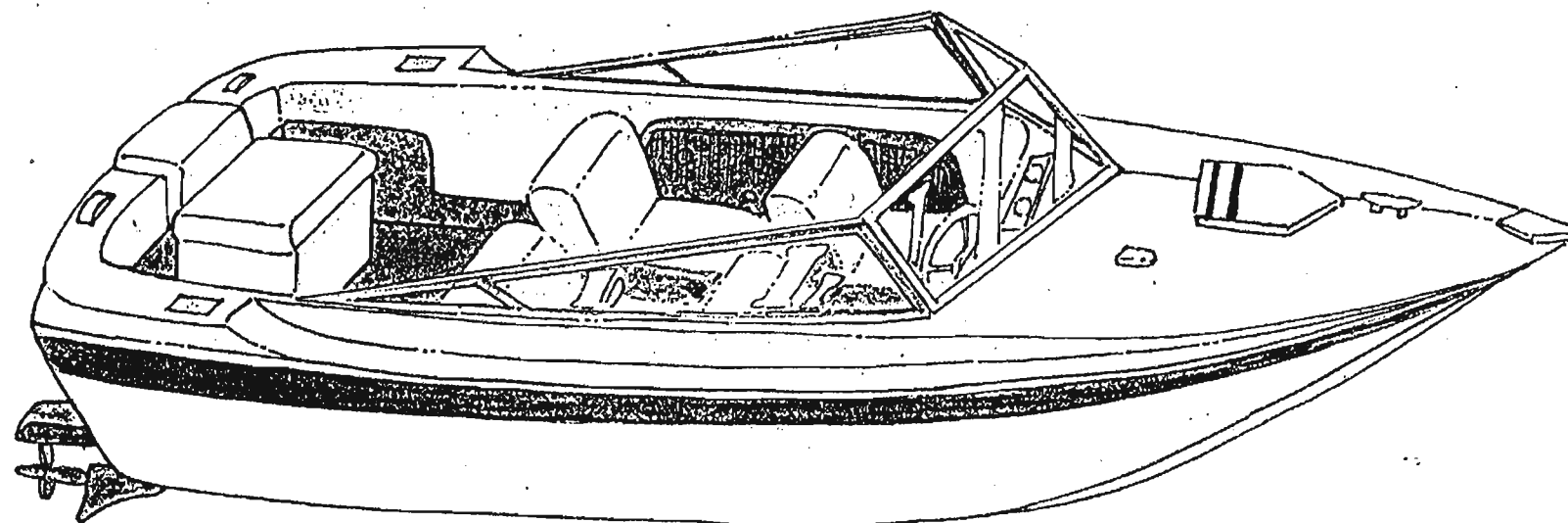

シェーンパイクの自家用車改定

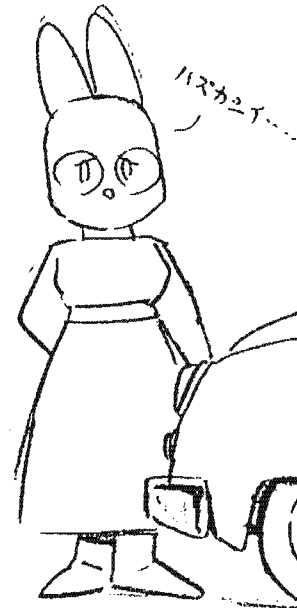
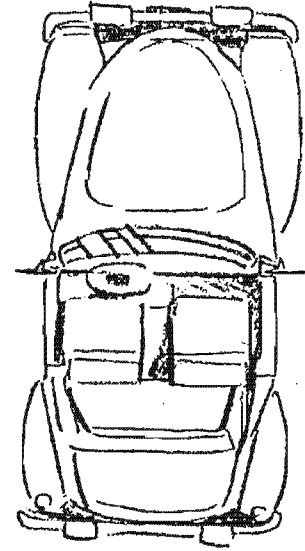

ハズカシイ...

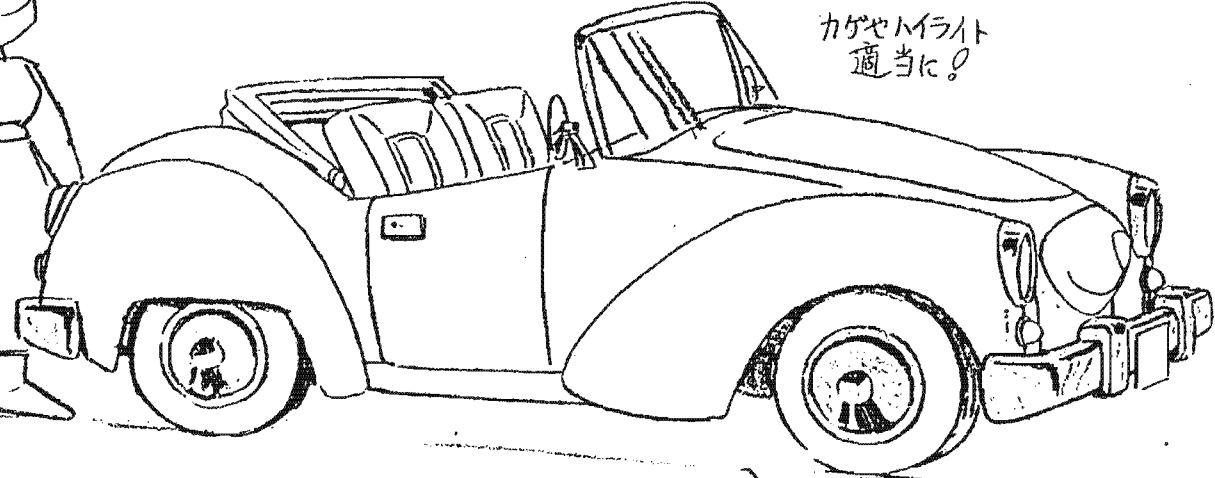

カゲヤムライト 適当に!

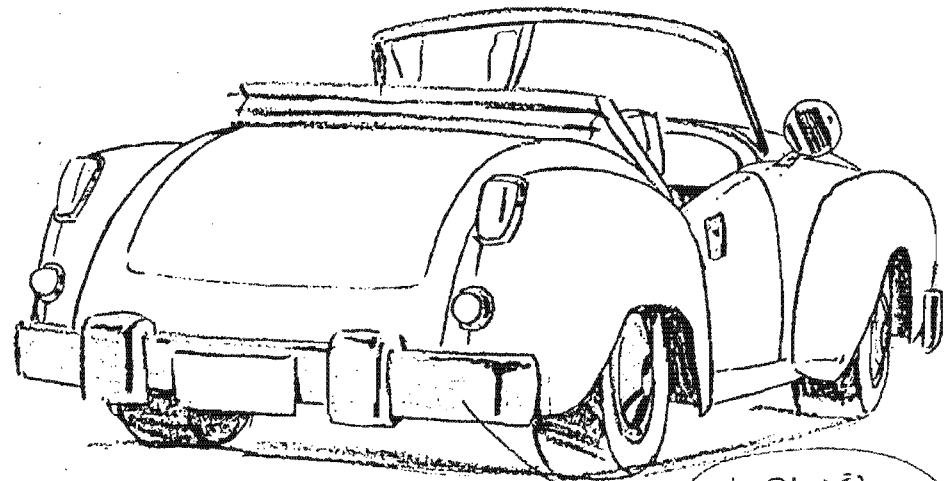

ハーフトン部
シルバー

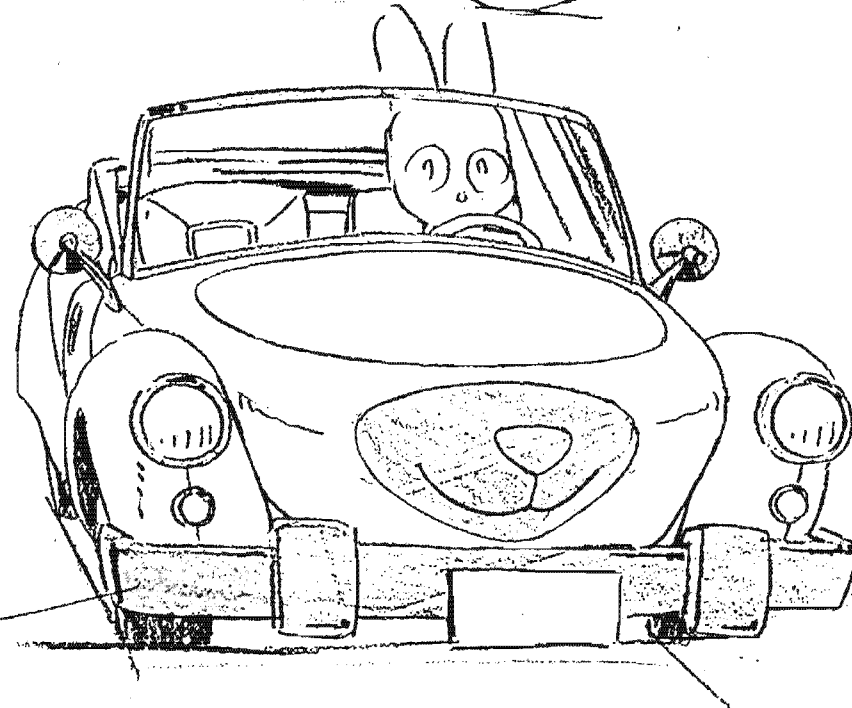

ジェーンパイクの白家用車

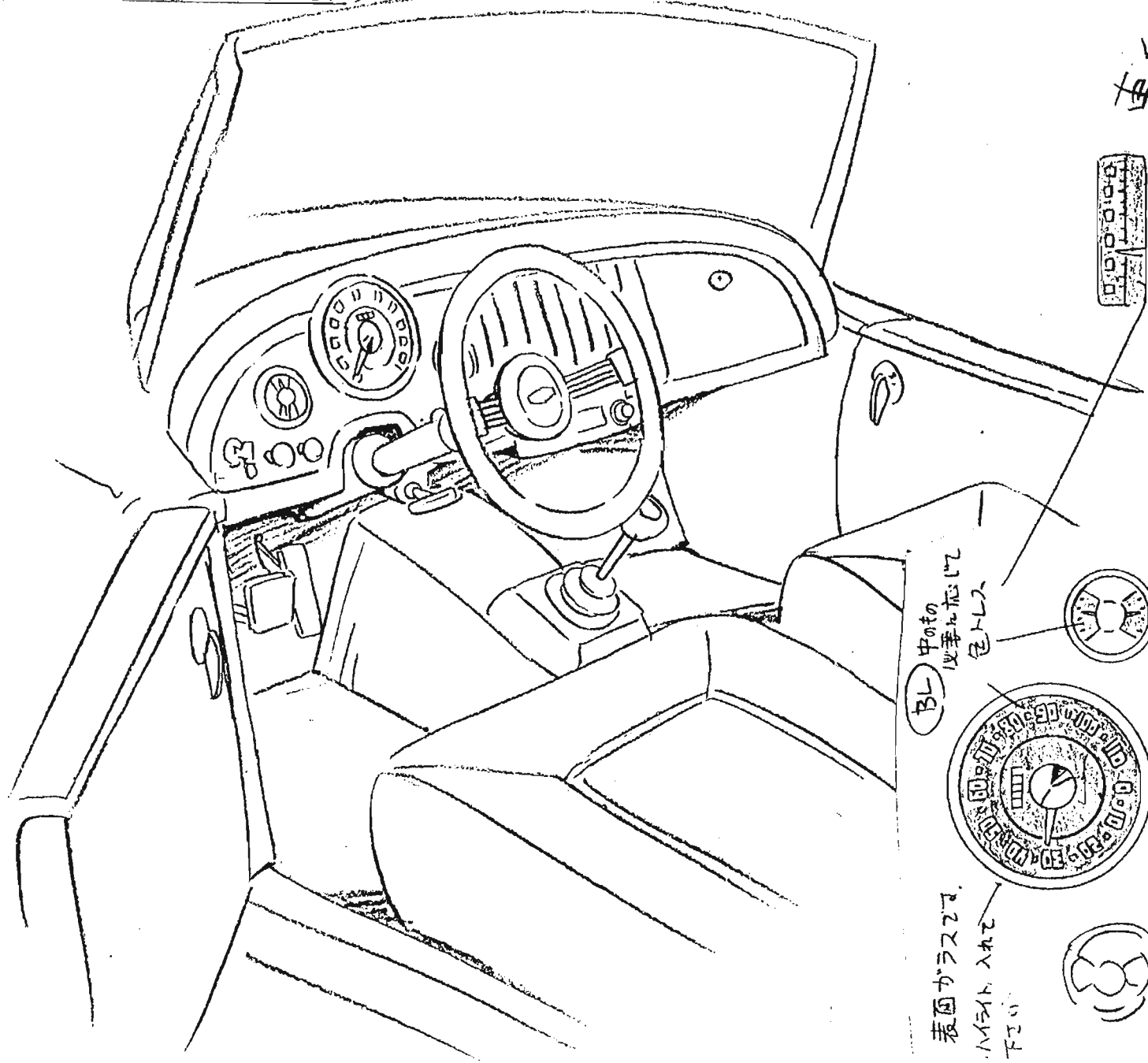

車体色

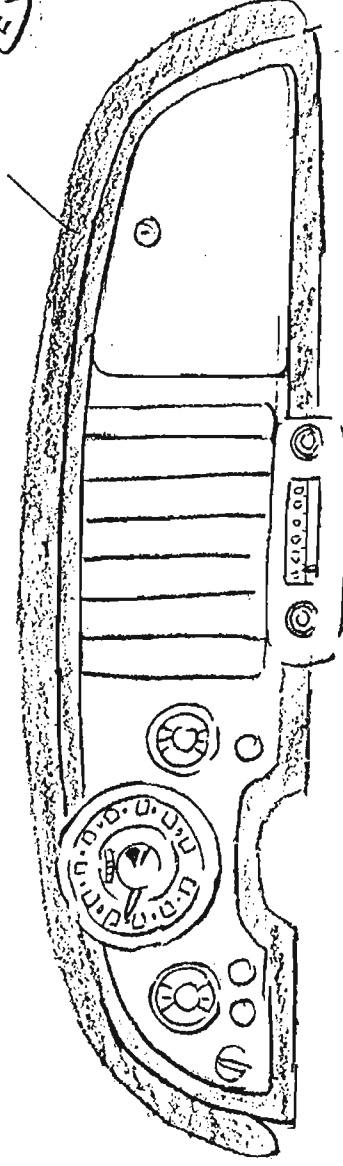

BL 中の
必要に応じて
色トレス

表面ガラスでは、
小文字を入れて
下さい

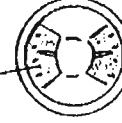
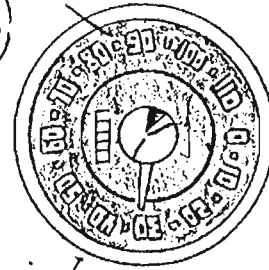

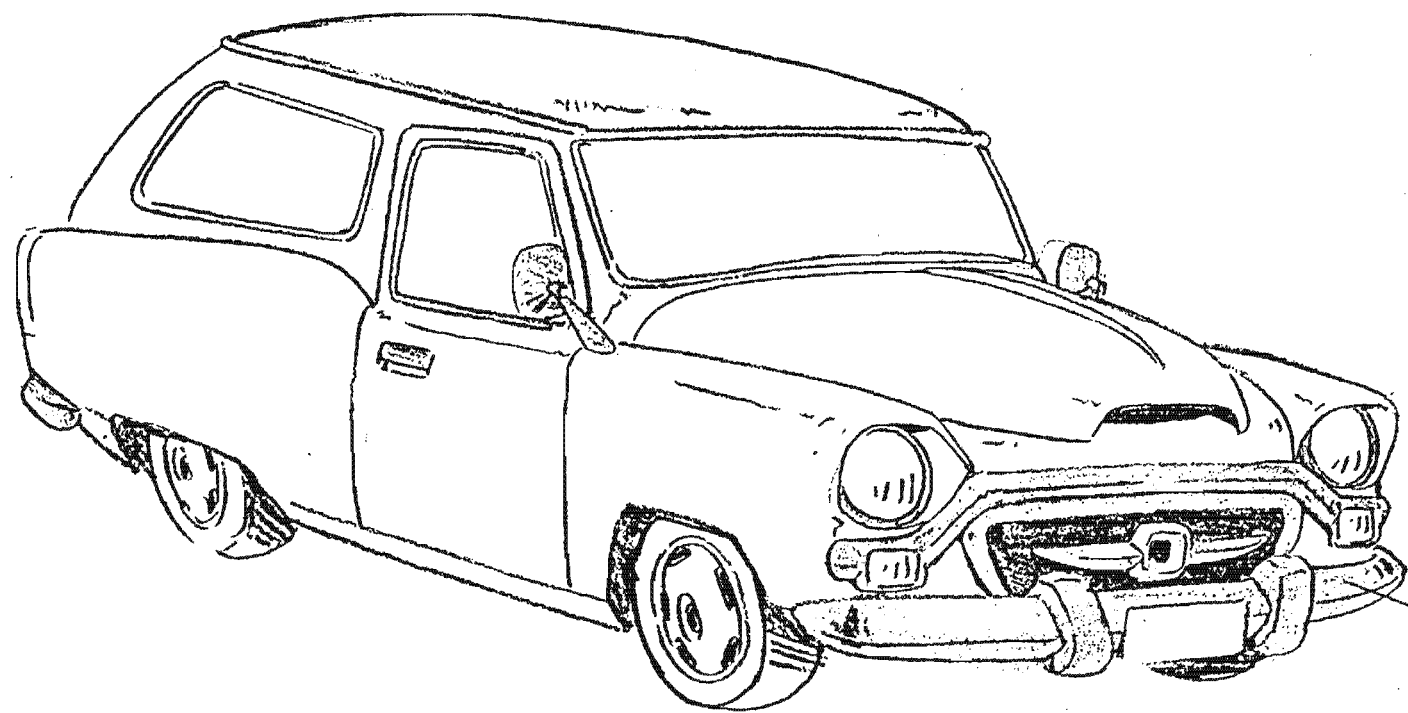

ハーフトーン部分は
シルバー

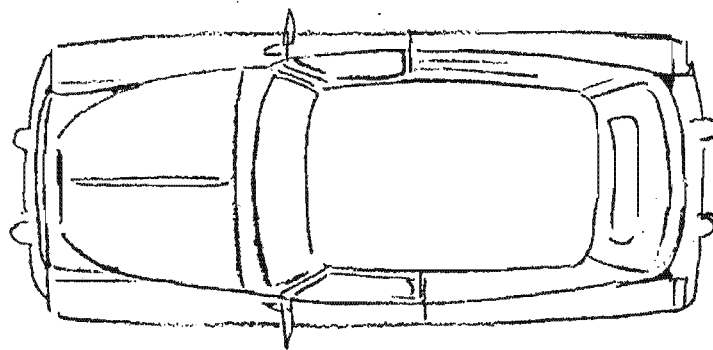

白クマカー ①

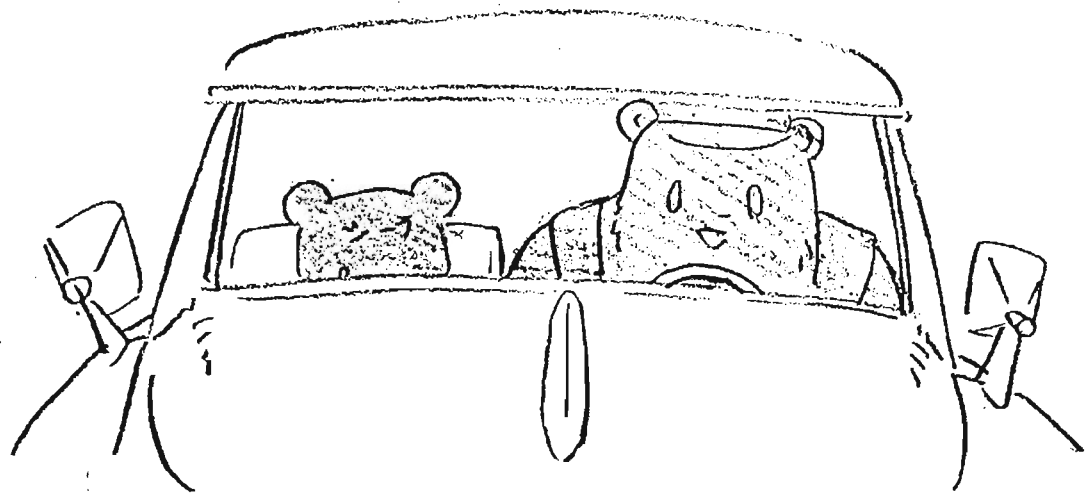
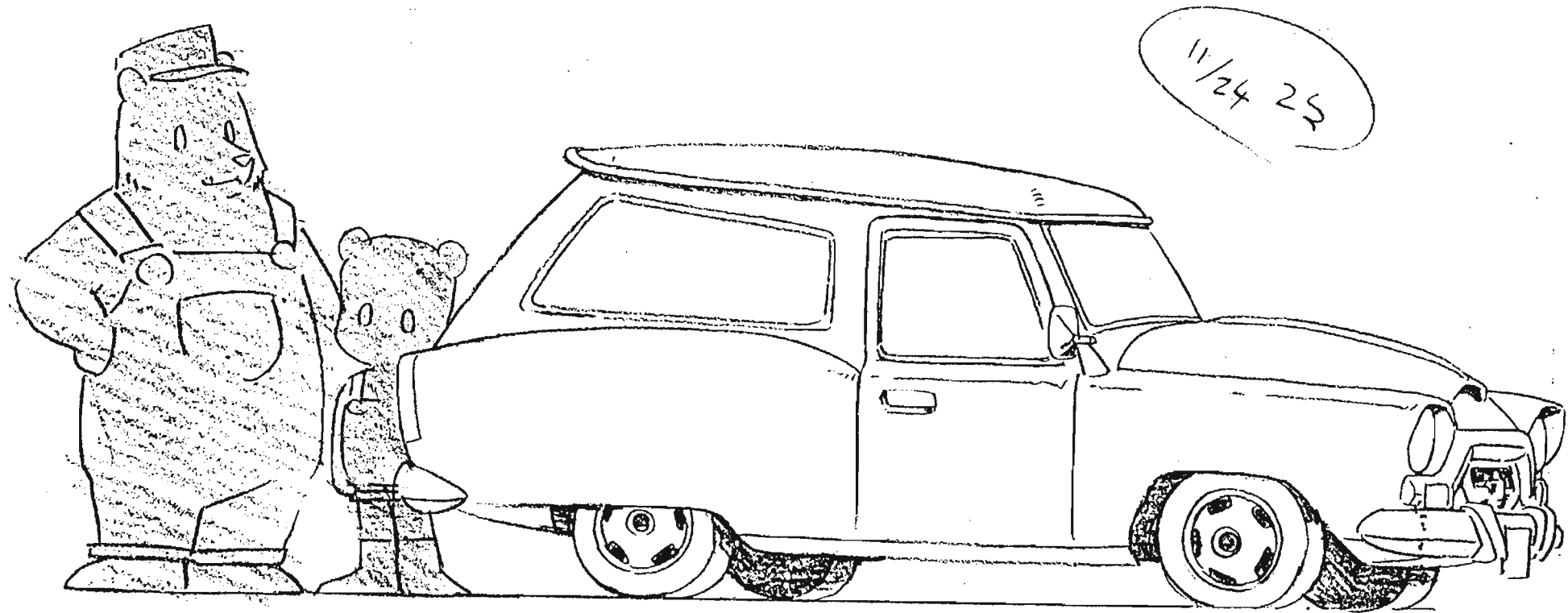

白クマカー②

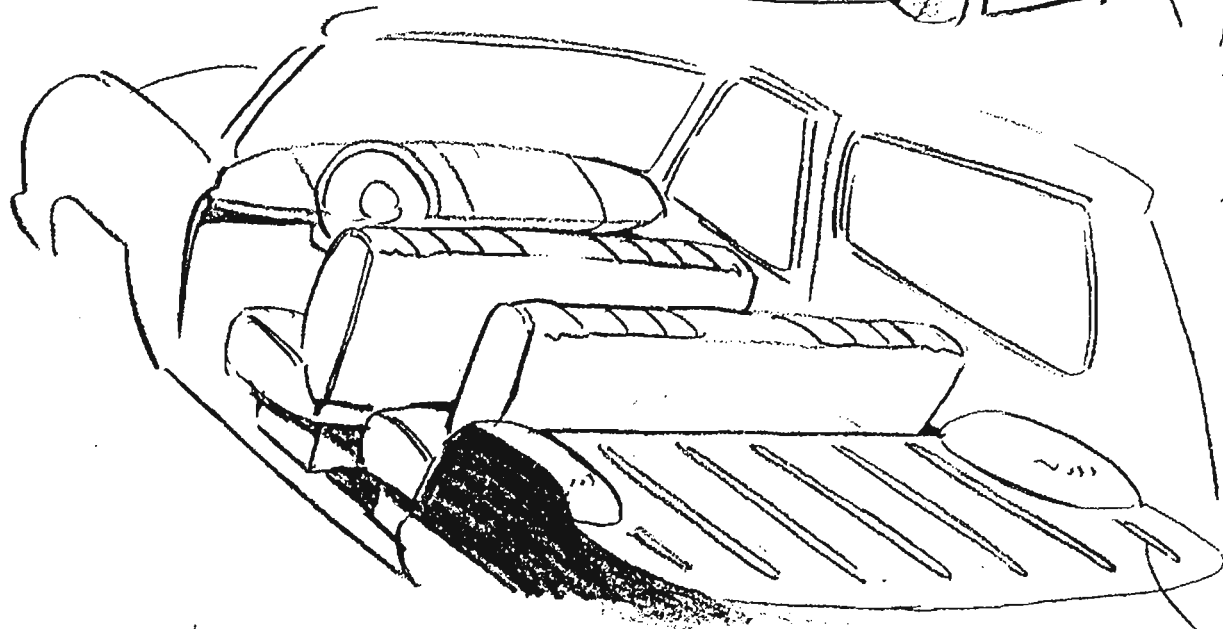
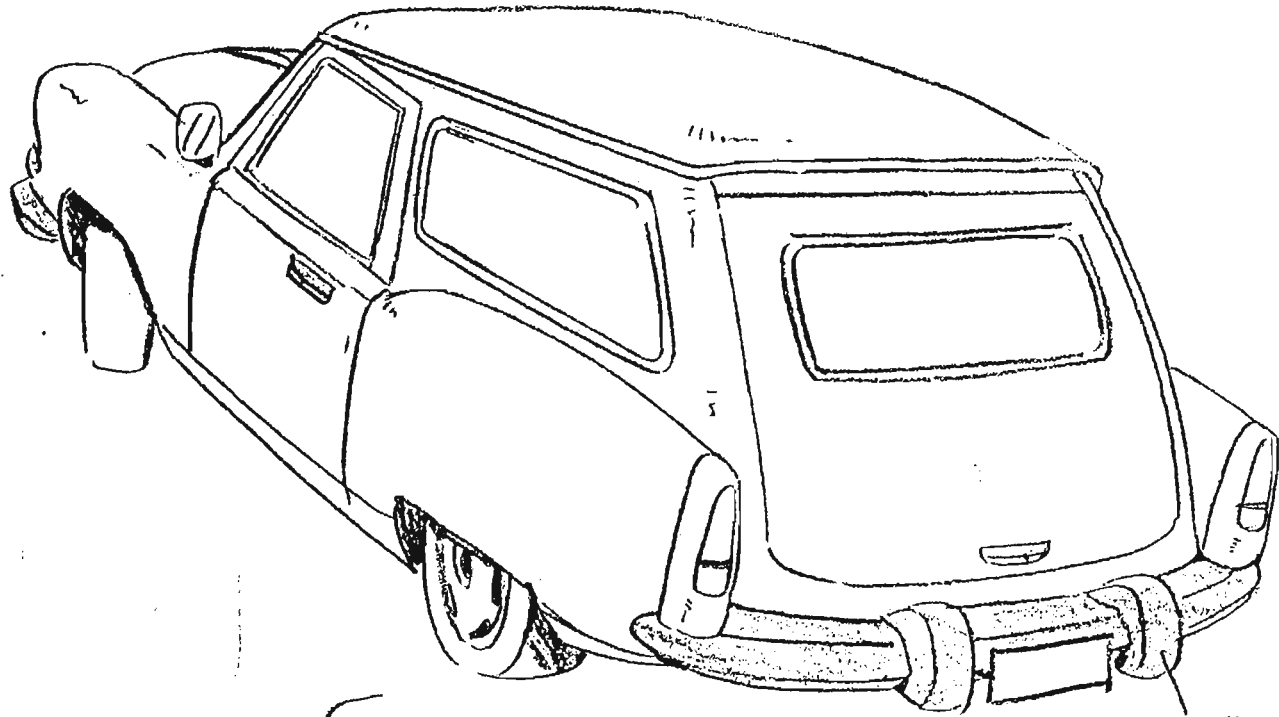

ハーフトーン部分はシルバー

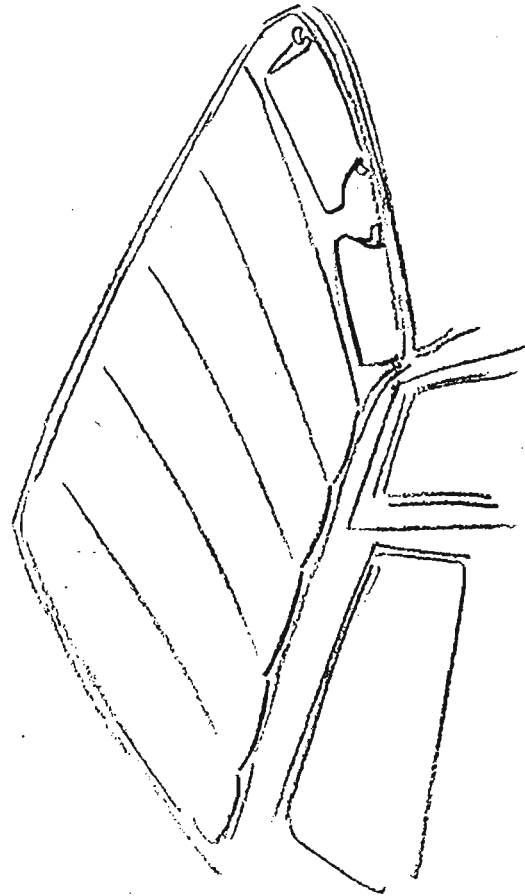

白ワマカー③



11/24 22

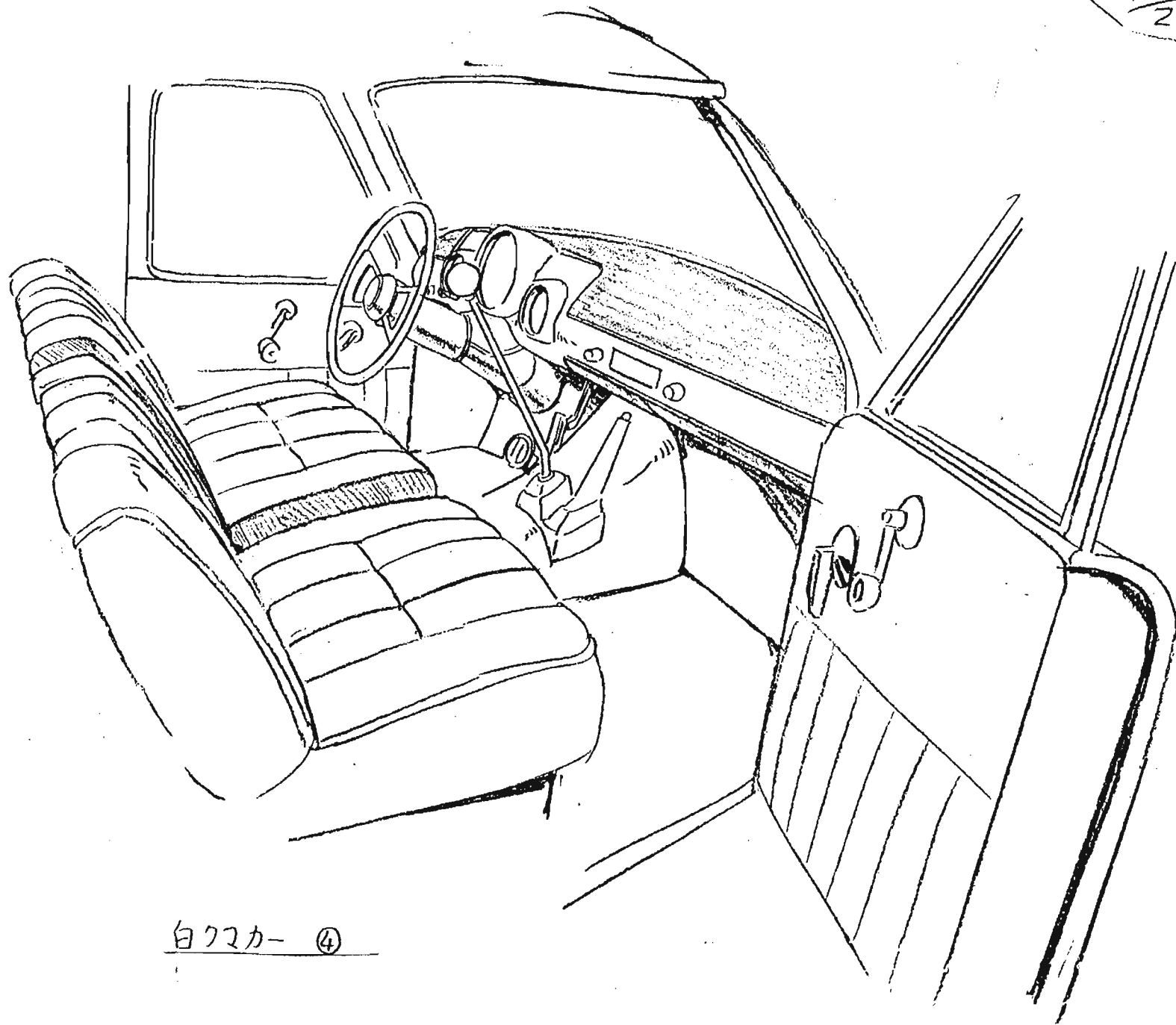

白マカ- ④

白クマカ

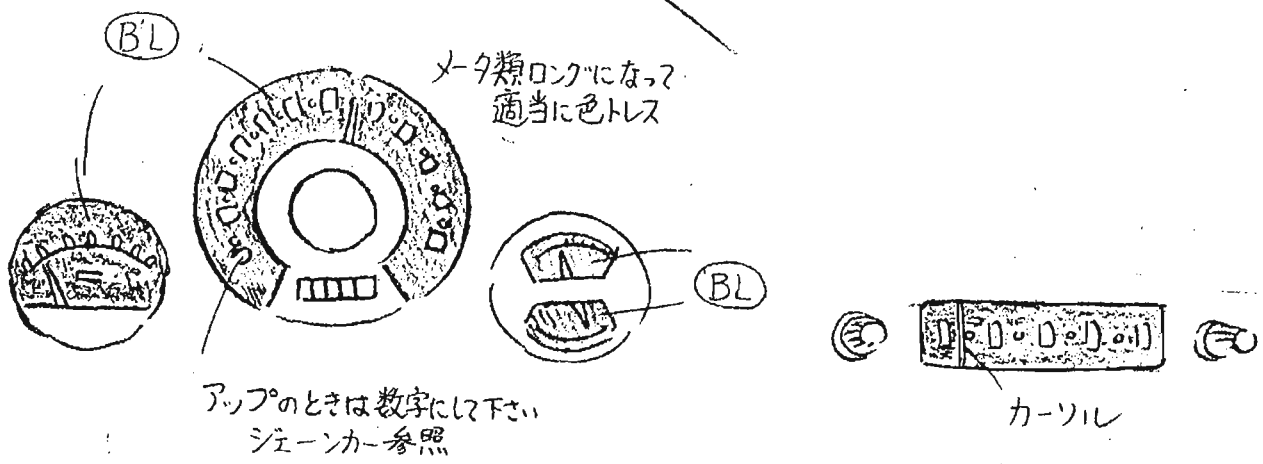
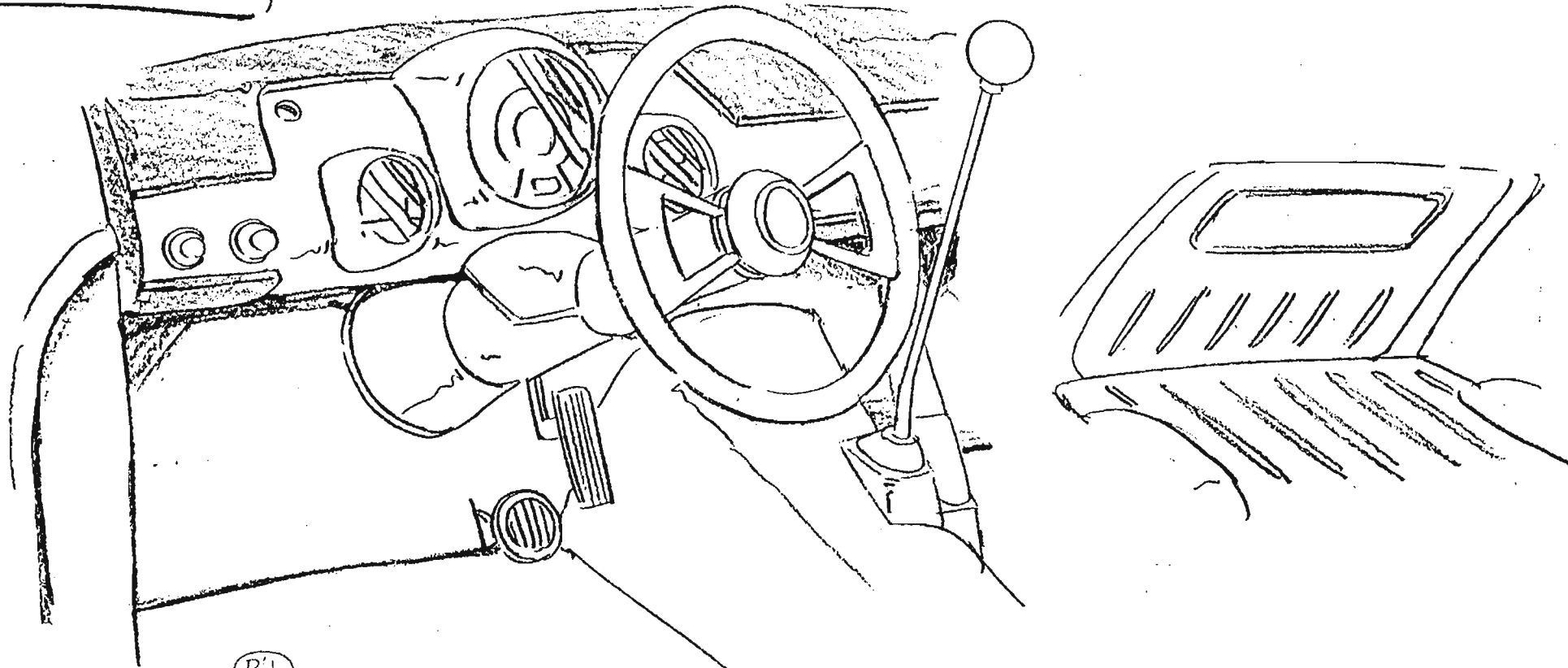



11/24 25

バランス
融通さかせて下さい

白クマカー

ゴルドンカー

11/22 改訂

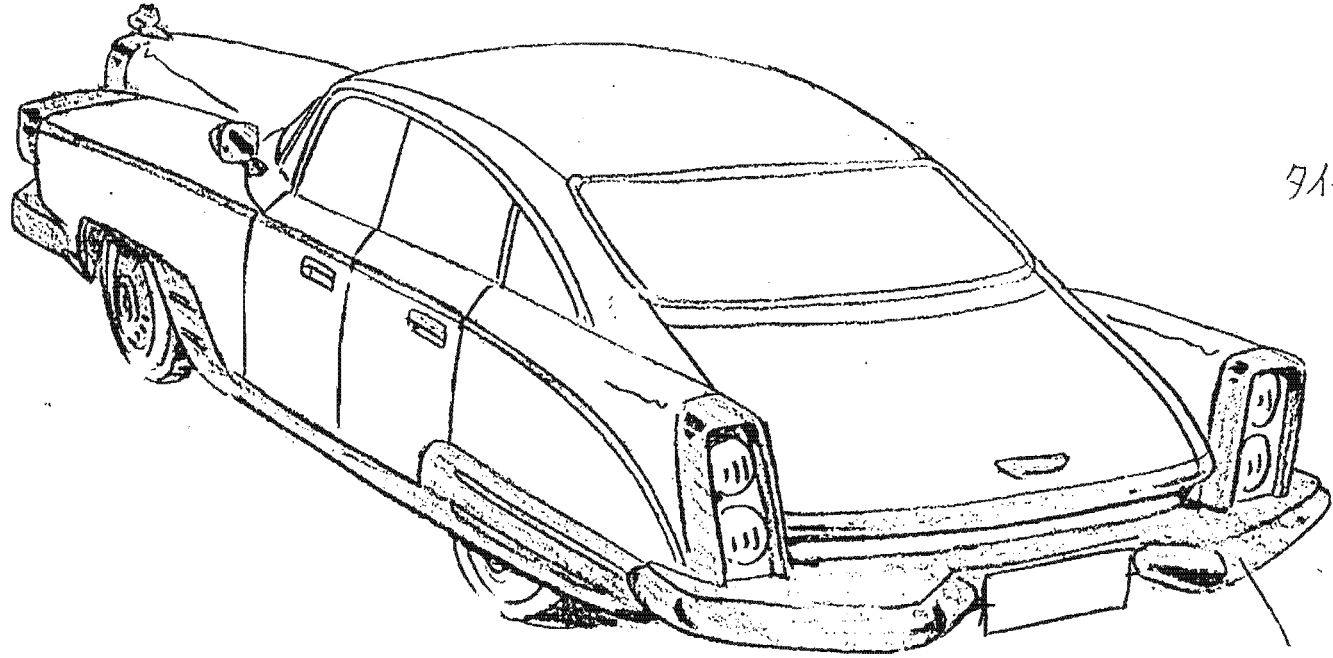

タイヤ色

白

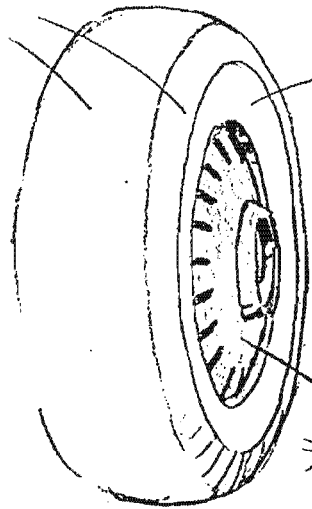

シルバー

ハーフトーン部分
シルバー

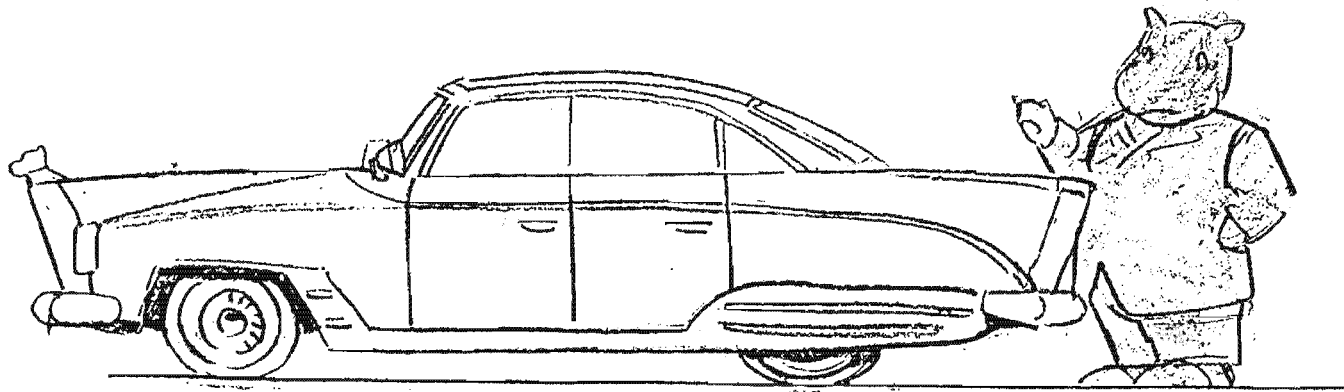

エルドンカー

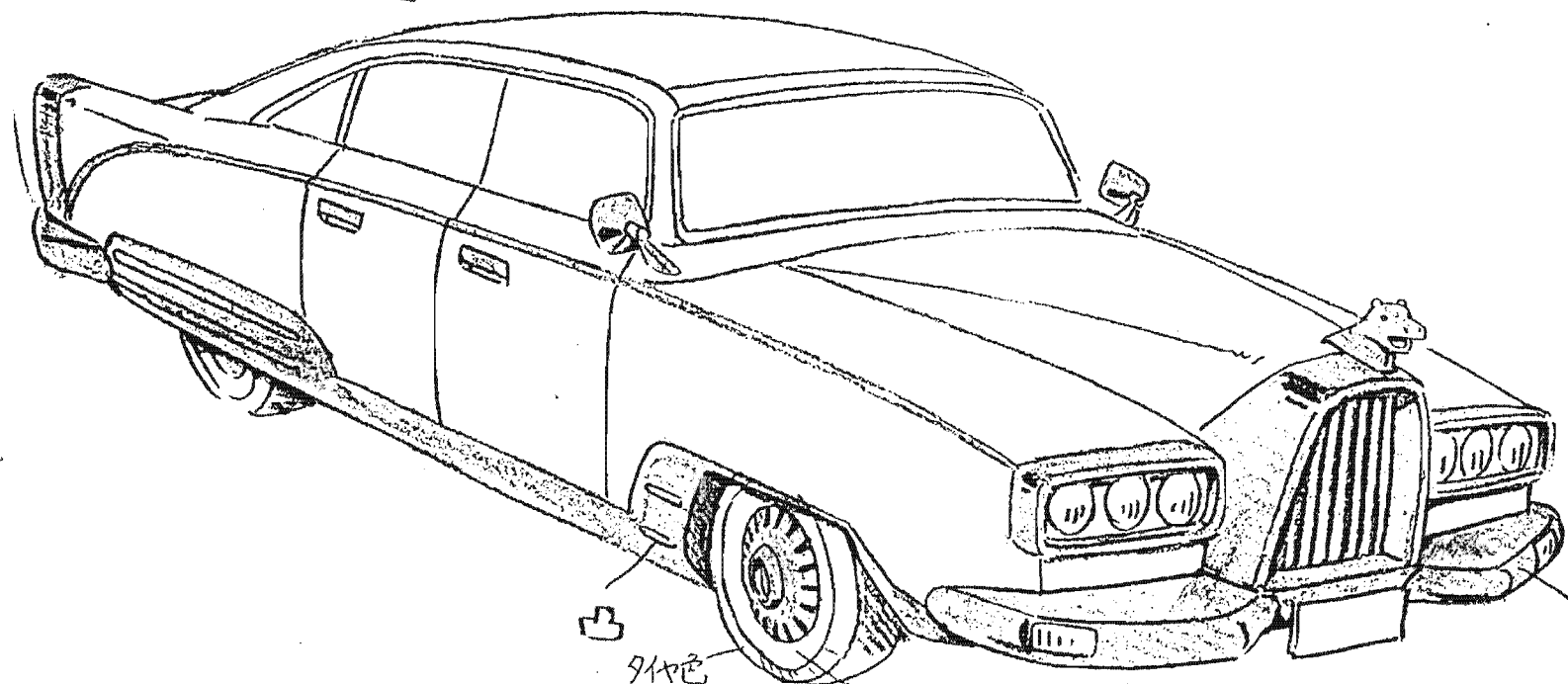

↑
タイヤ色
白

ハーフトン部分
キラキラシルバー

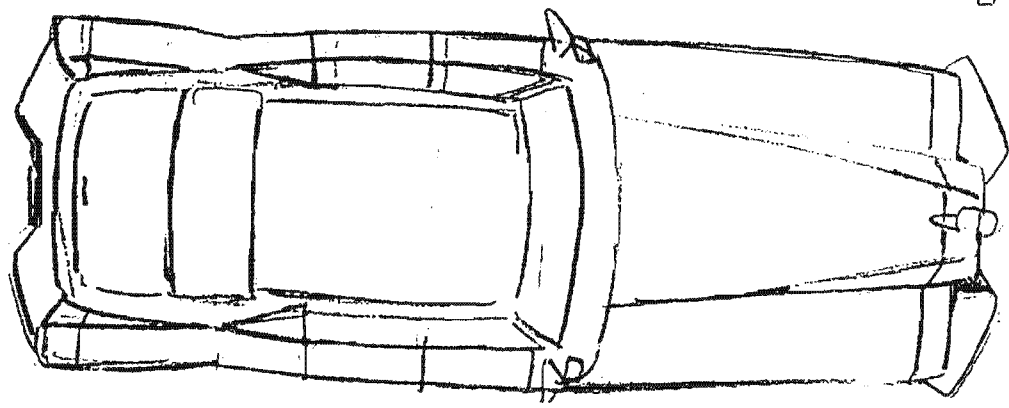

ゴールドンカー

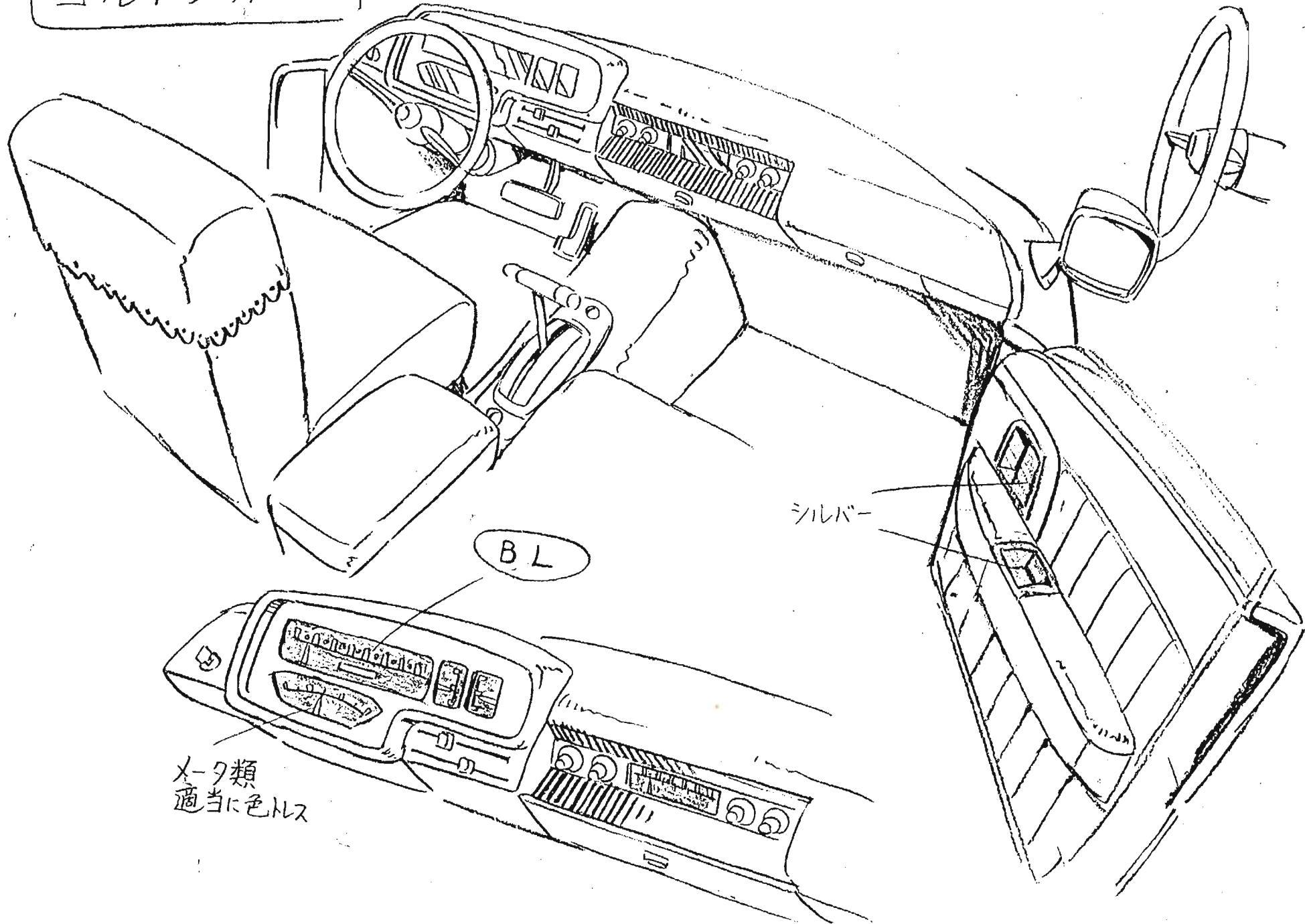

BL

シルバー

メータ類
適当に色トス

コルドンカー



コルドンカーは白クマカーと同じくらい
の大きさですが自動車が巨大なので
白クマカーに比べて、少しゆたか
います。

22新造

コルドランカー

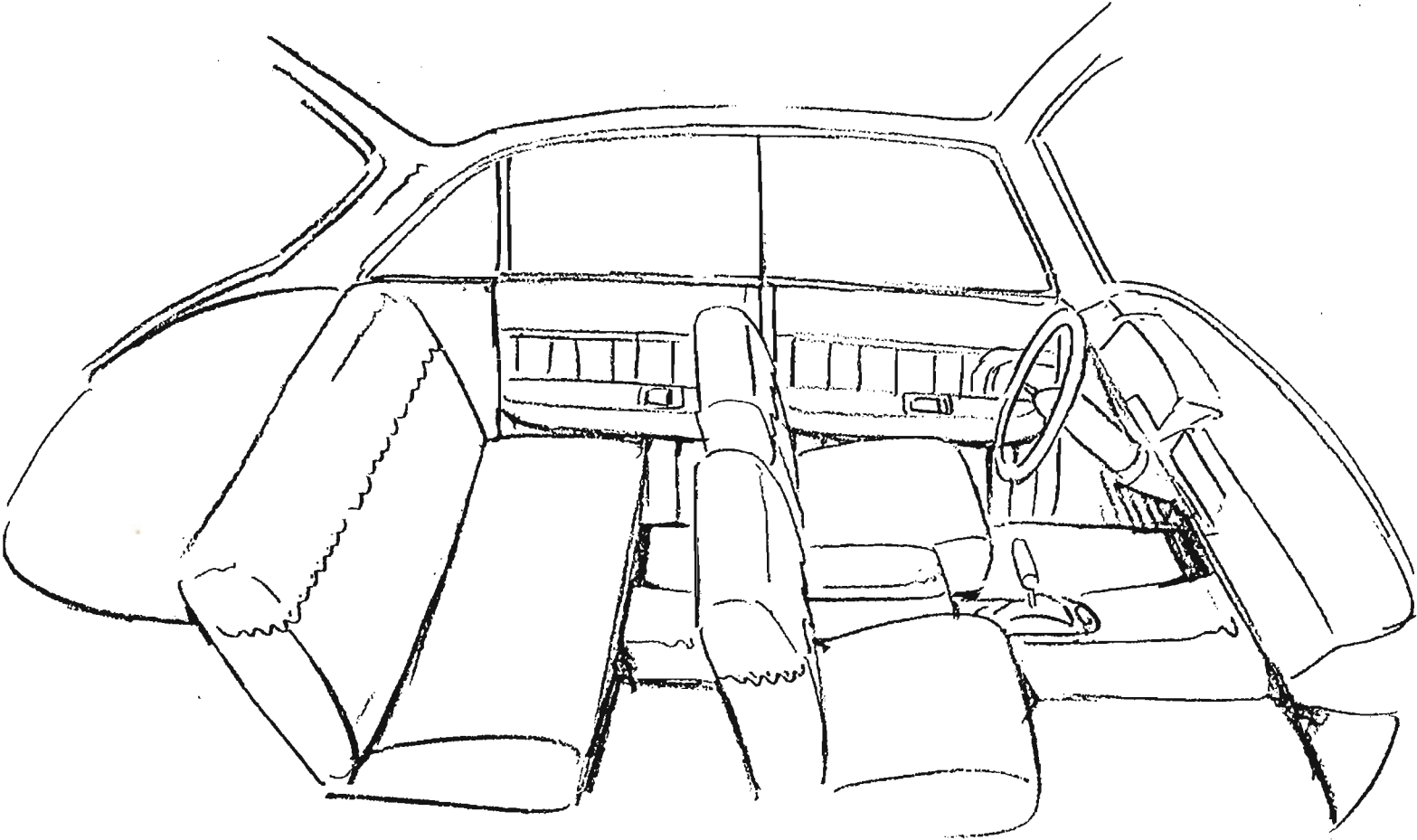

モケイカー

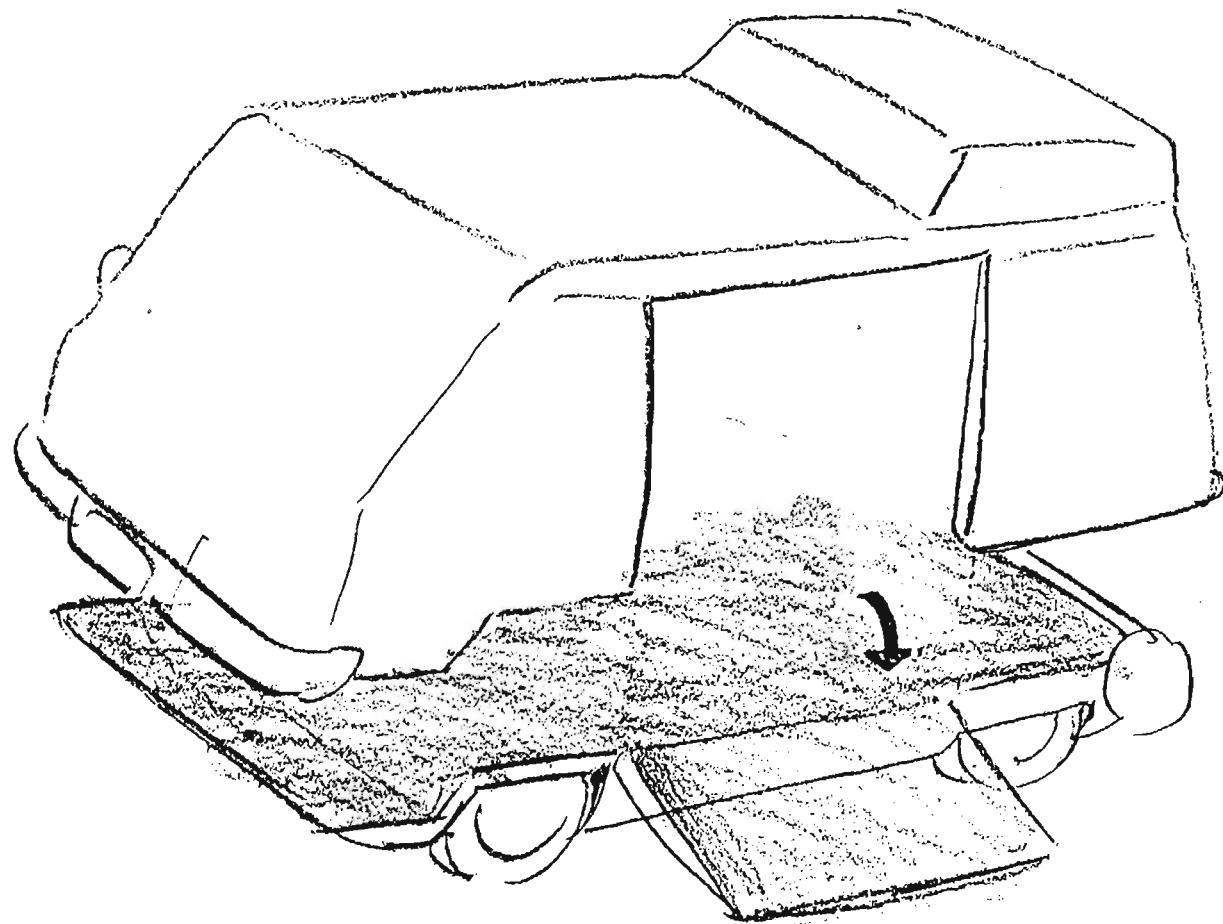

ラフ

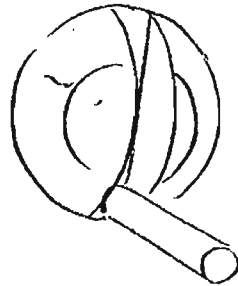
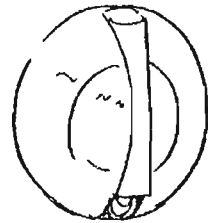
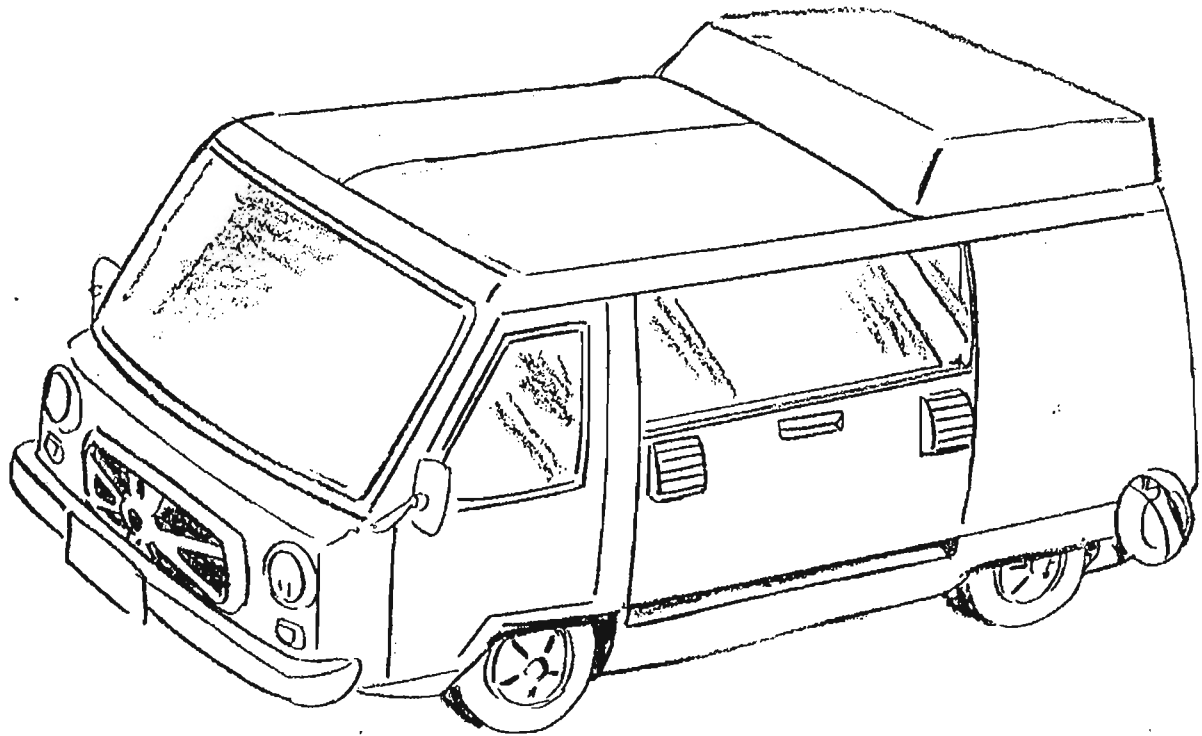

ガラスはドアに
収納されます



ゴム
パット

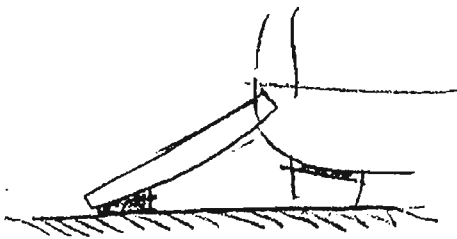
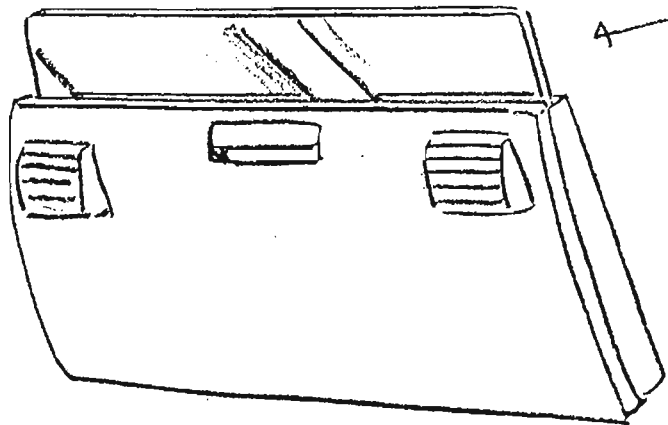

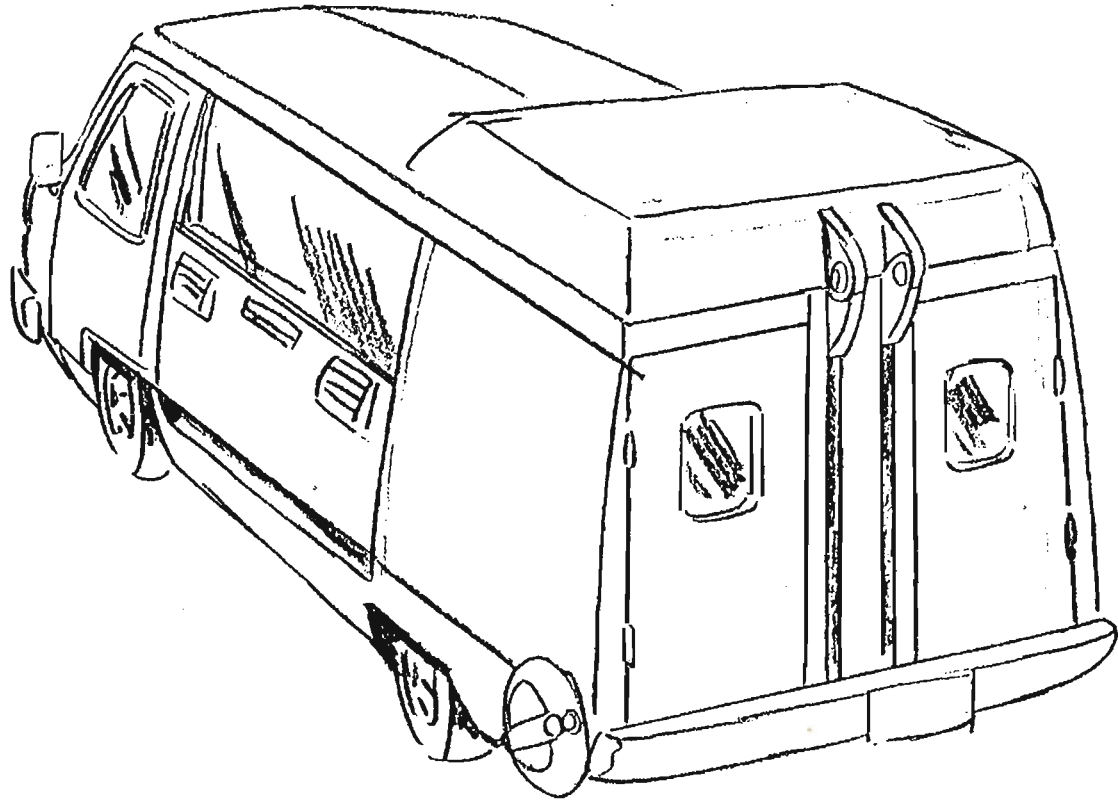

多目的力一

ラフ

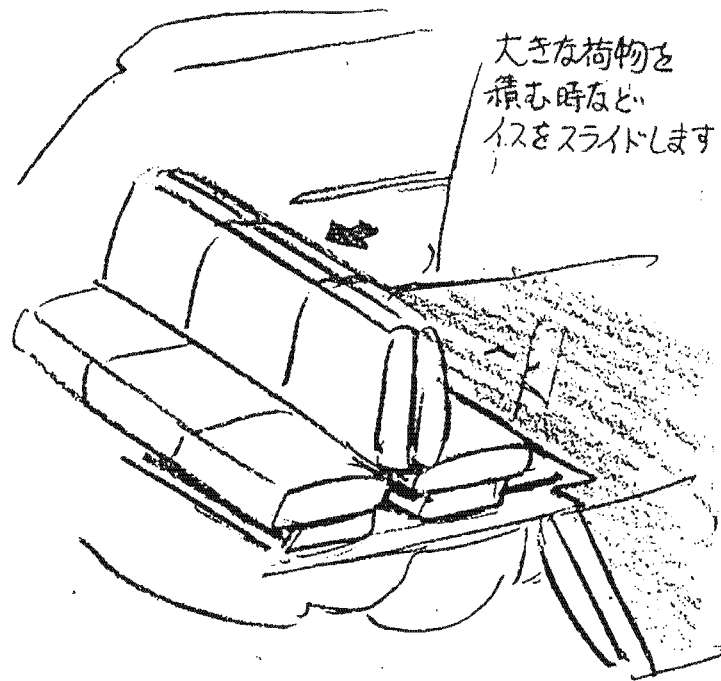
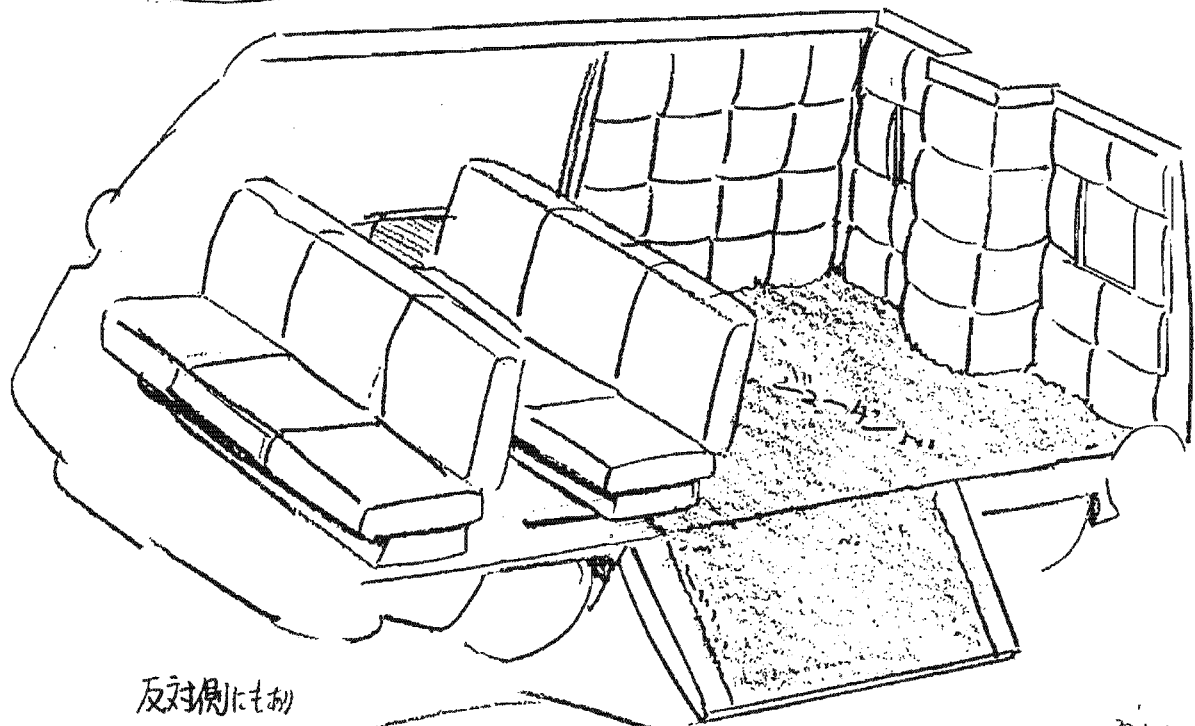

大きな荷物を
積む時など
イスをスライドします

反対側にもあり

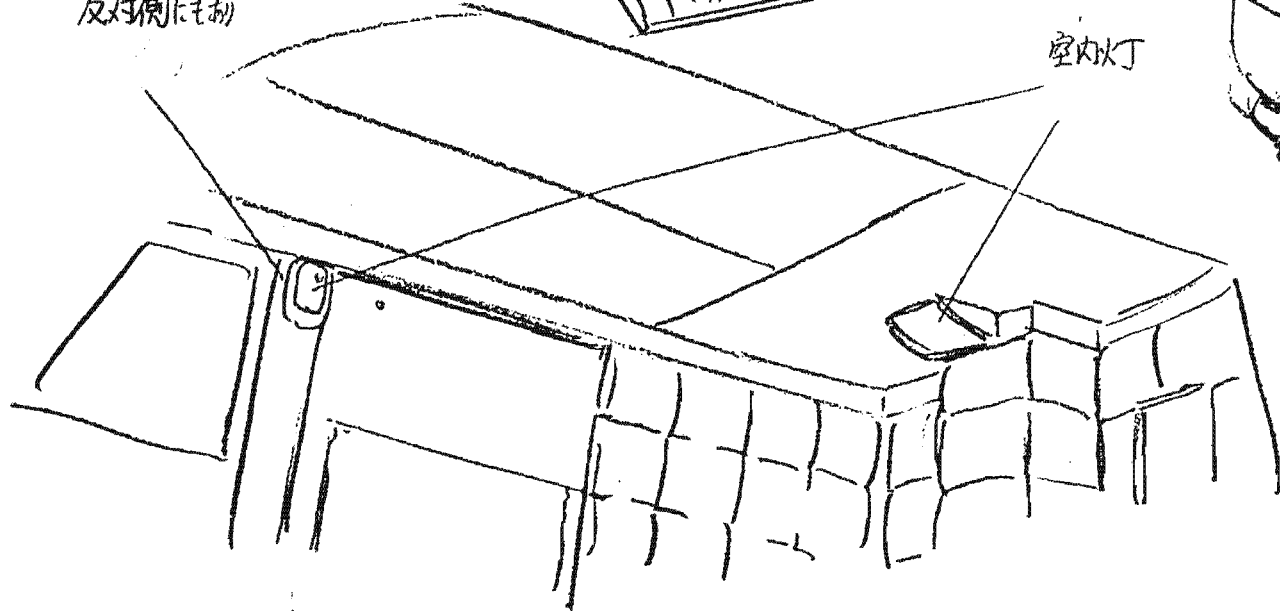

室内灯

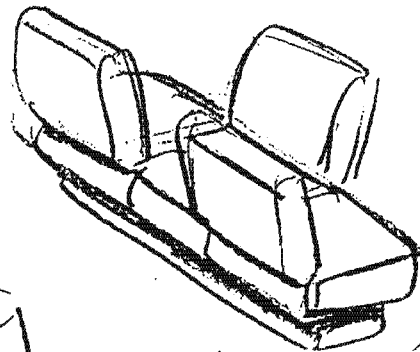

イスの背もたれは
独立可動します

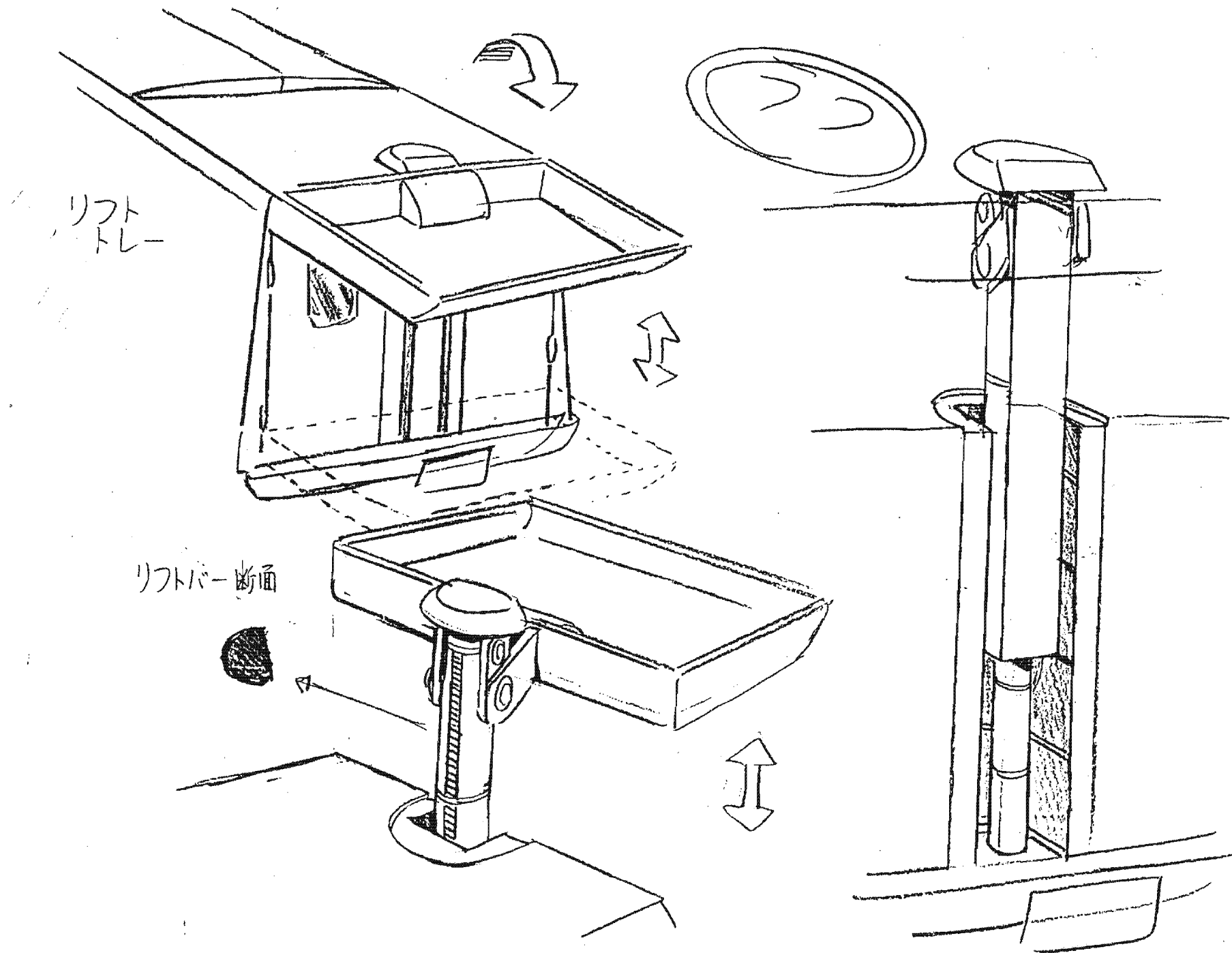

キャブカー

53

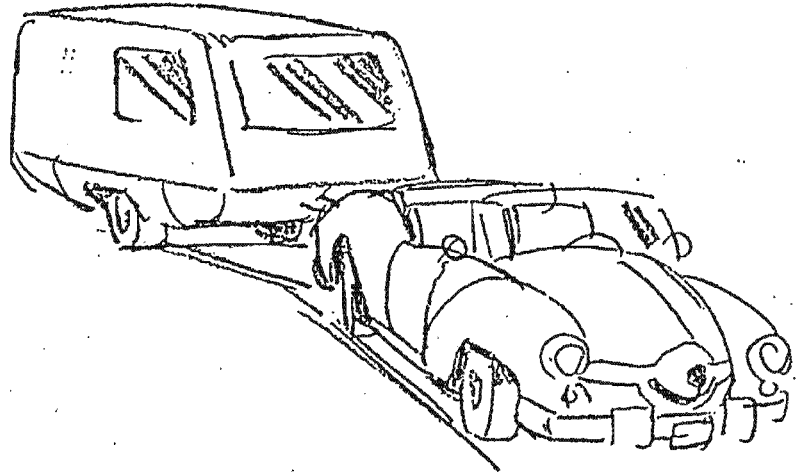
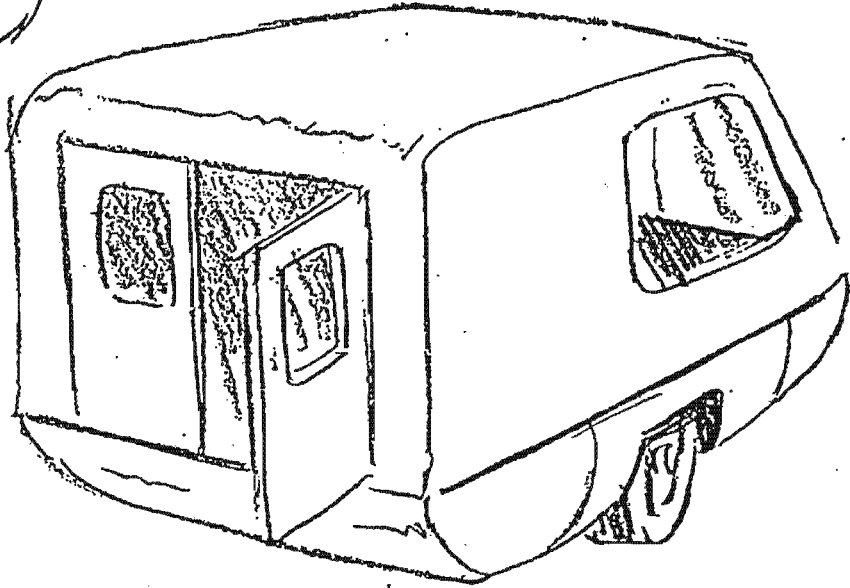
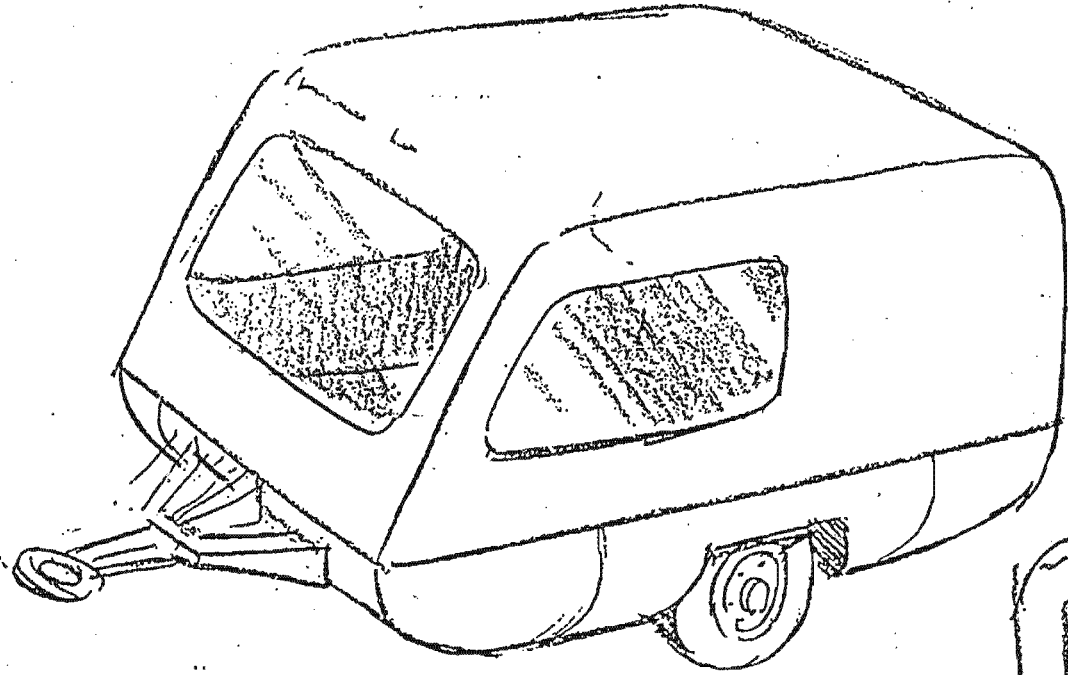

アイスクリーム・ワゴン



アイスクリームワゴン

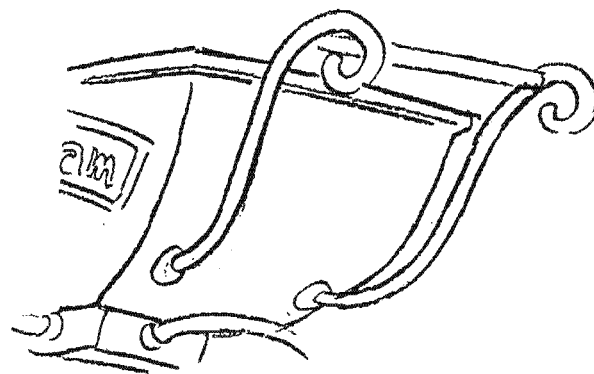
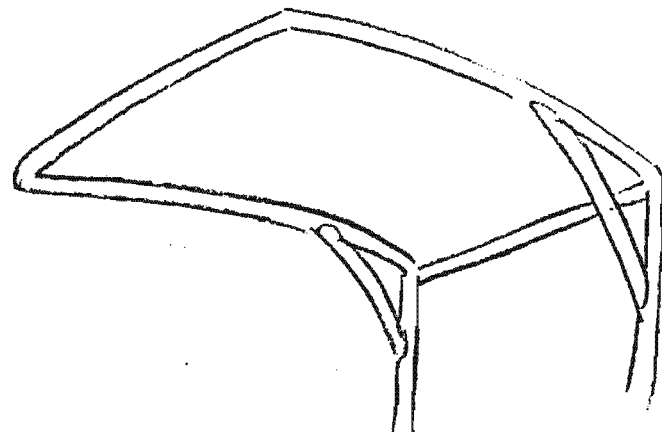
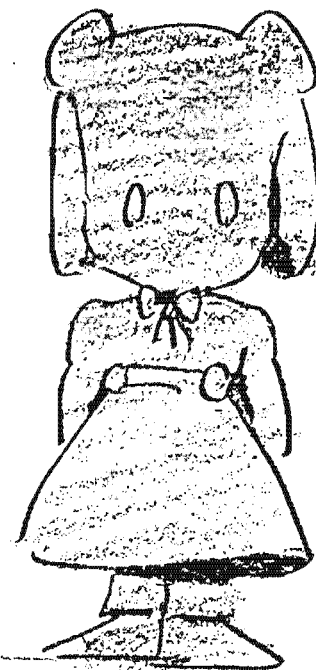
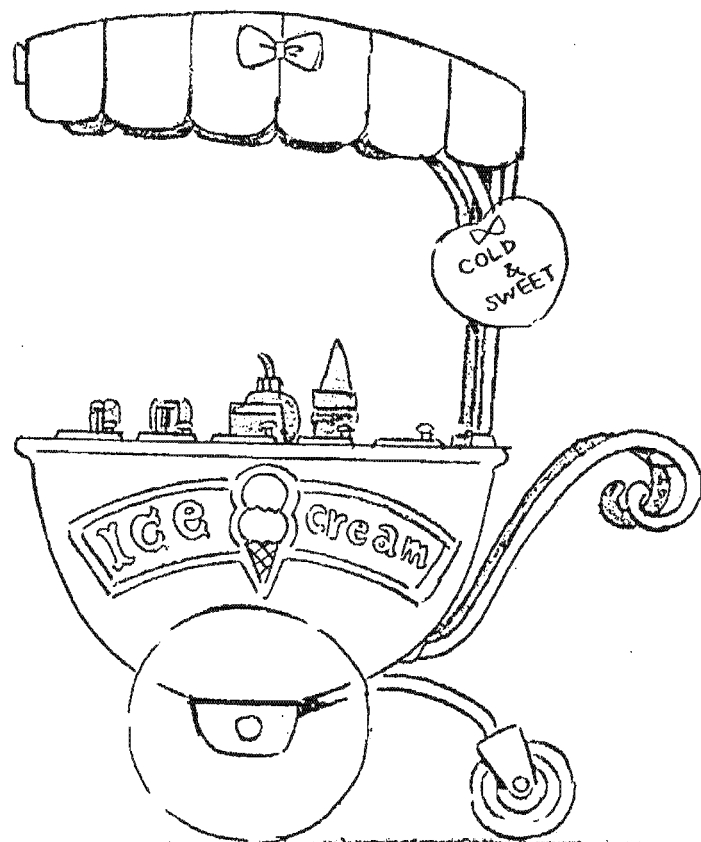
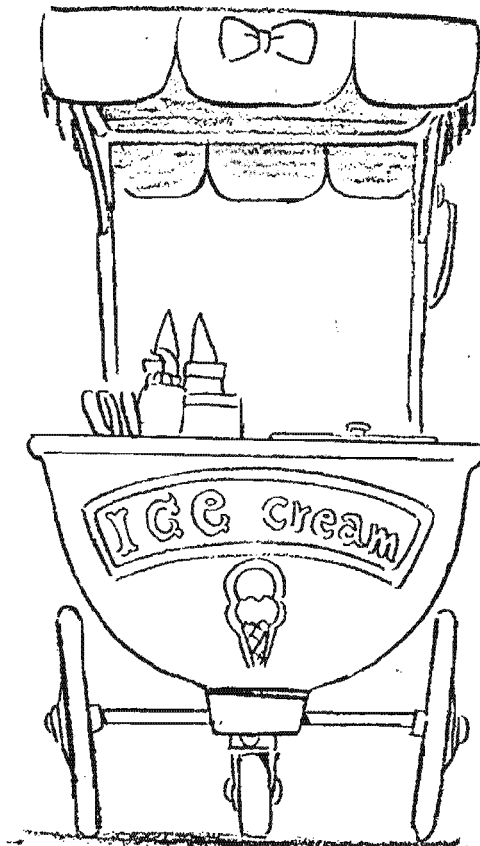

アイスクリーム・ワゴン

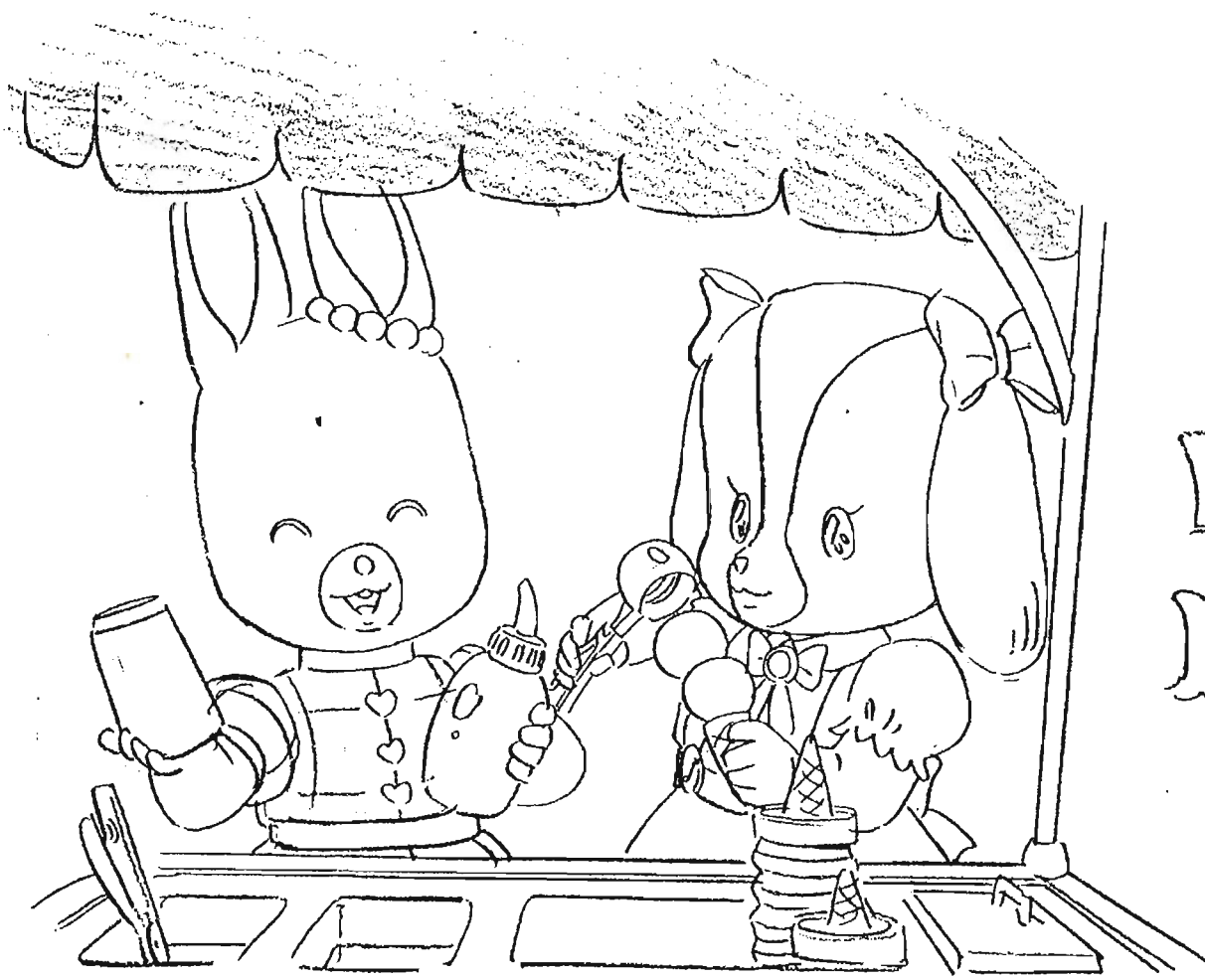

シロップ

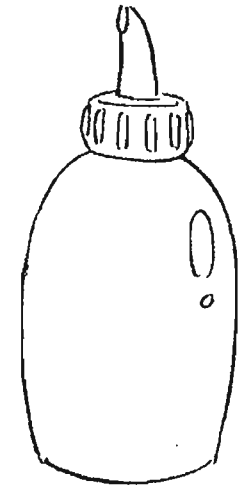

ロゴマーク

Ice cream



ロングの場合



色トレス

11/22. 改

アイスクリームワゴン

水が入っている

金庫

フタのヒンジ側の
へりはきりたっています

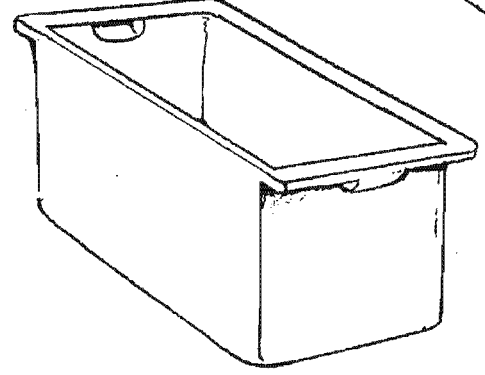

アイスケース

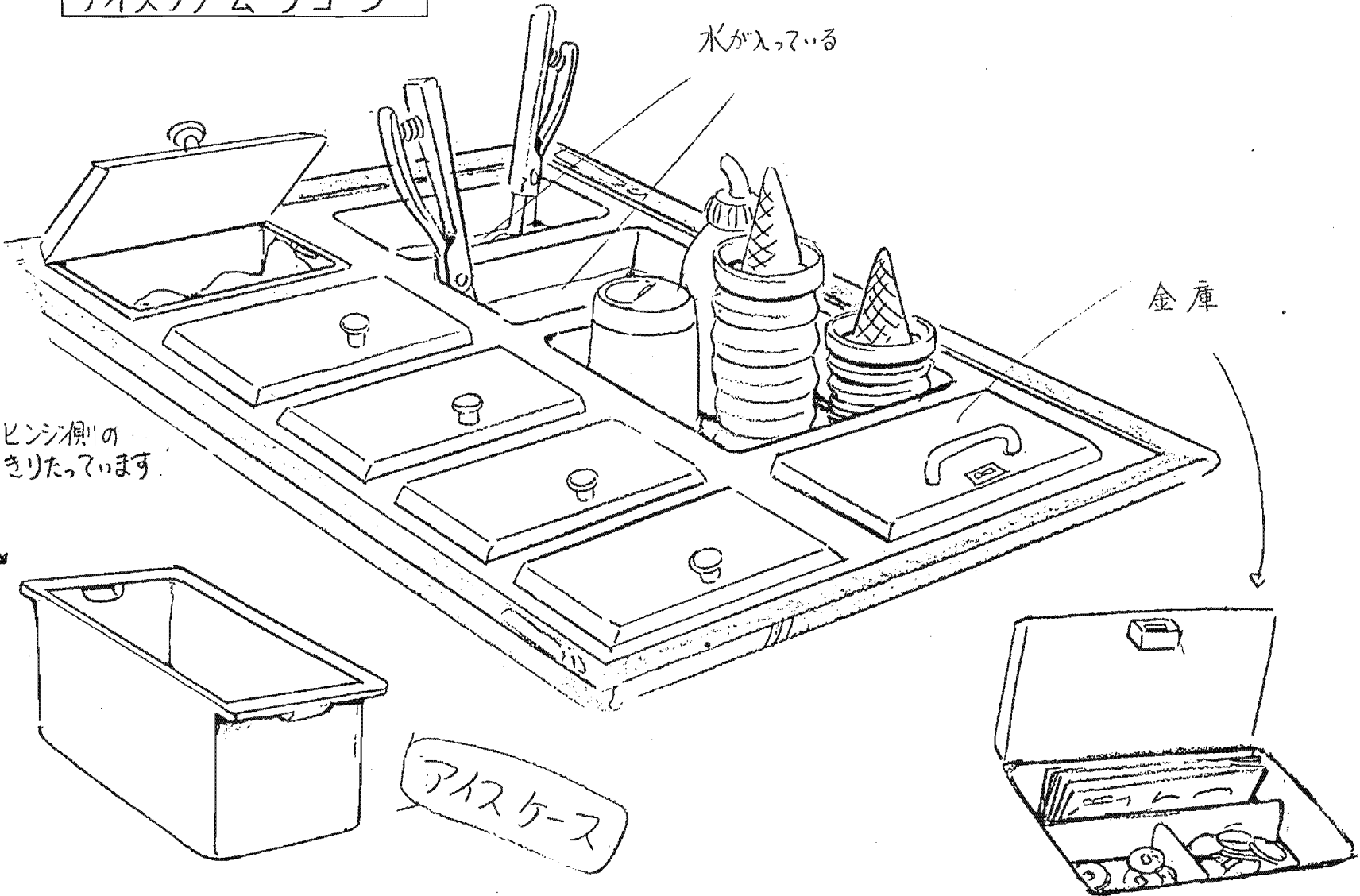
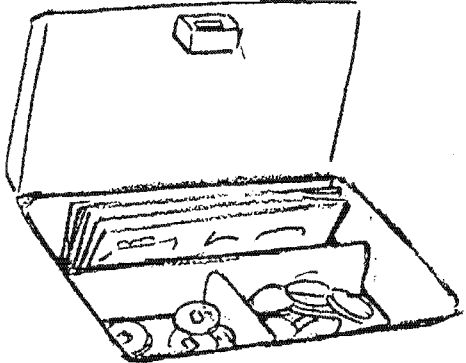

アイスディッシャー

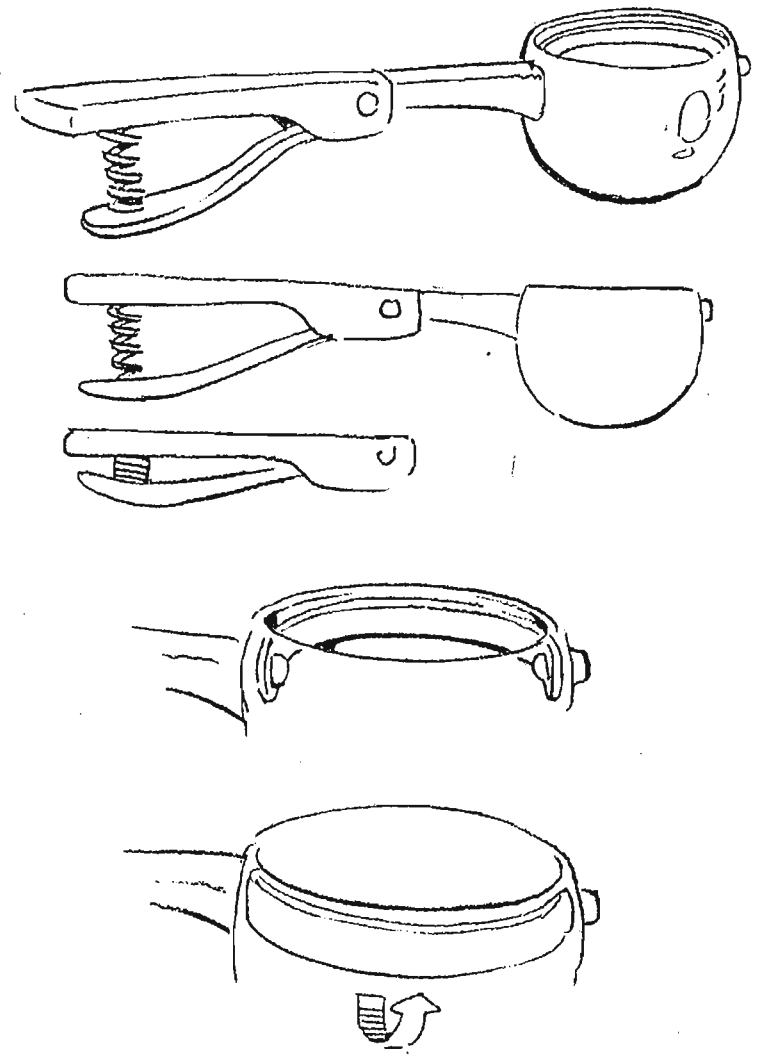

コーンホルダー

コーンが減ってくと
低くなってマスコ縮む

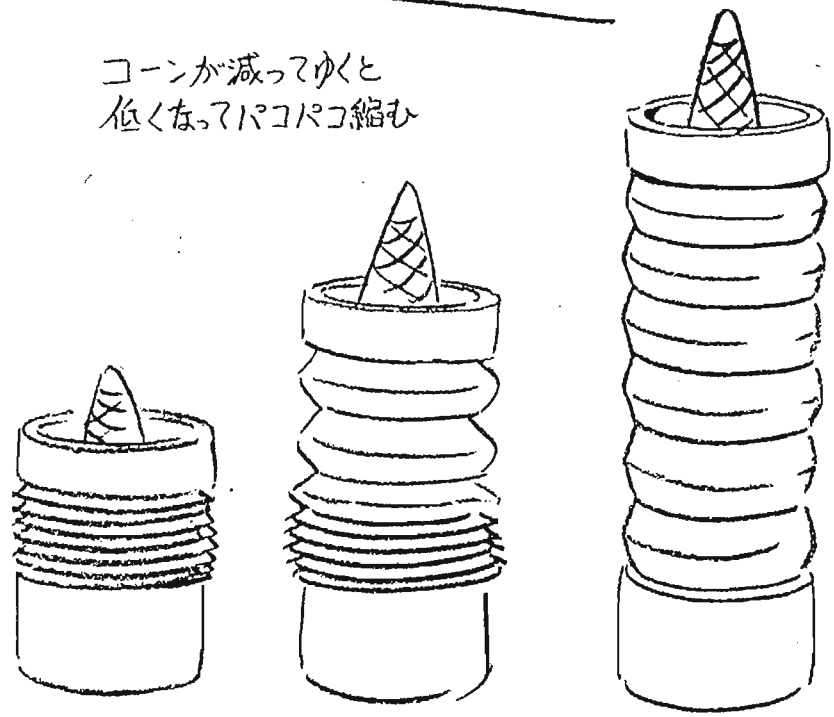

チョコチップふりかけ

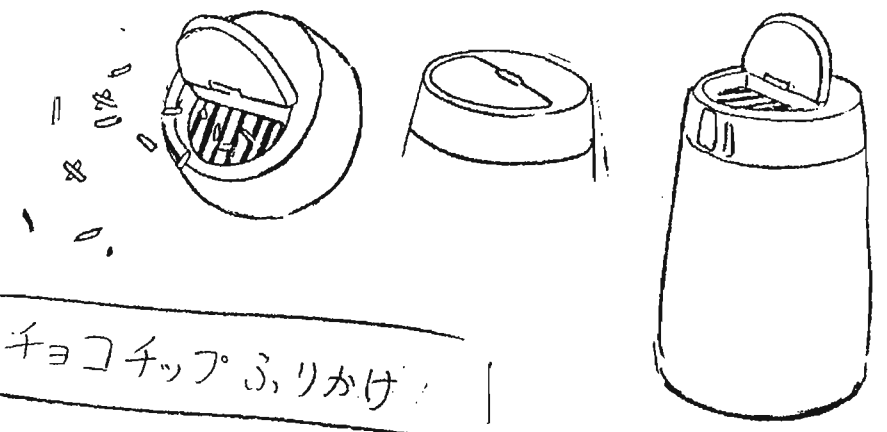

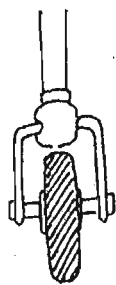
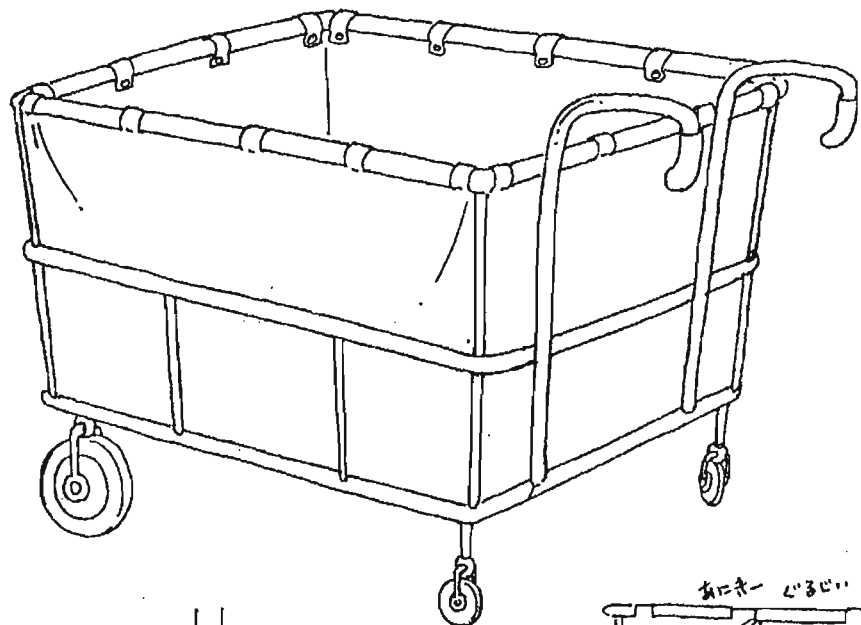

車のつき方(方向が自由に
変えられます)

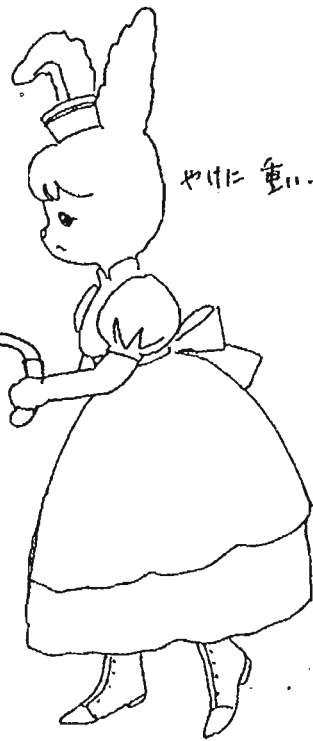
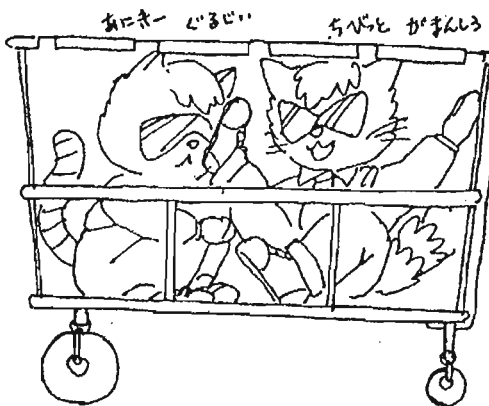

やはり重い……

パイカクリニックの洗たく物ワゴン

POP CORN

ハタ
ハタ
ハタ

引き車の方が見たワゴン

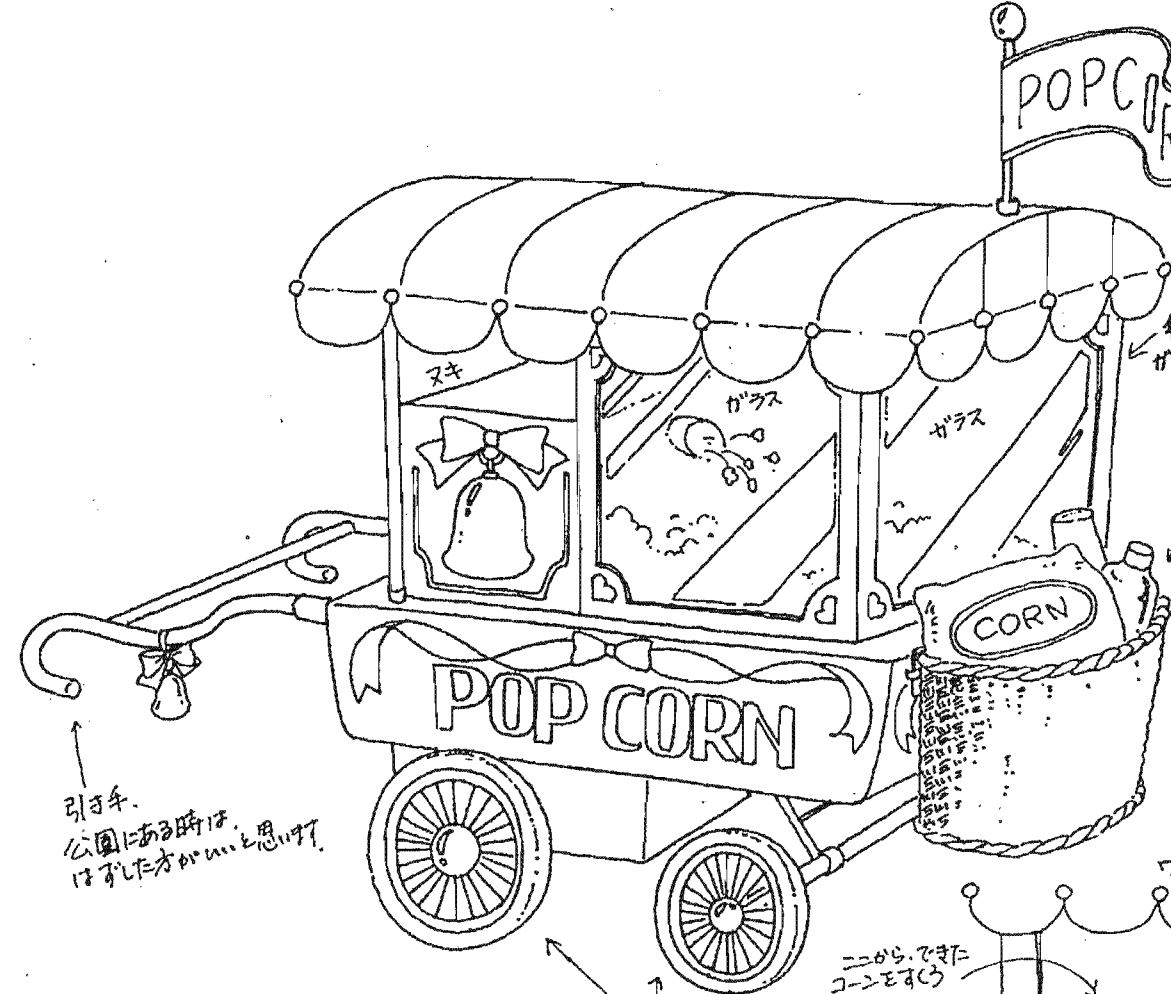

引き車、公園にある時は、はすした方がよいと思ひます。

羊のチャールとマリーのポップコーンワゴン

自転車の車輪とほぼ同じ

後はガラスなし。

回転棒を入れるところ

バスケット(材料、紙コップ等を入れる、取り出し可)

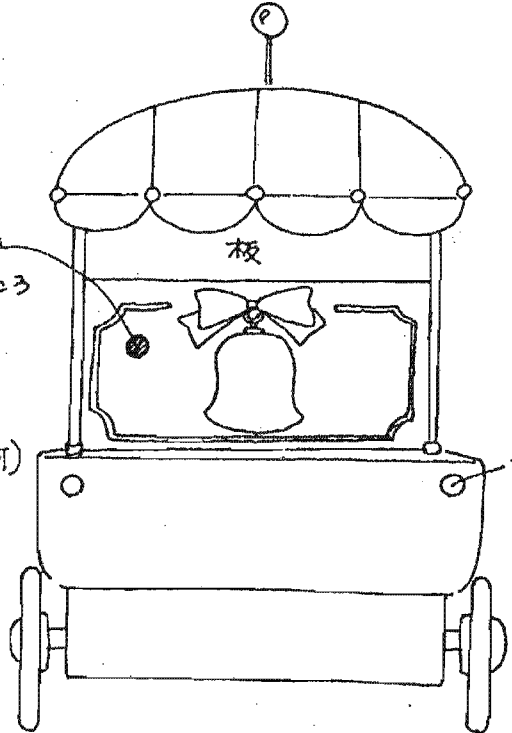

引き車

ワゴンの裏側

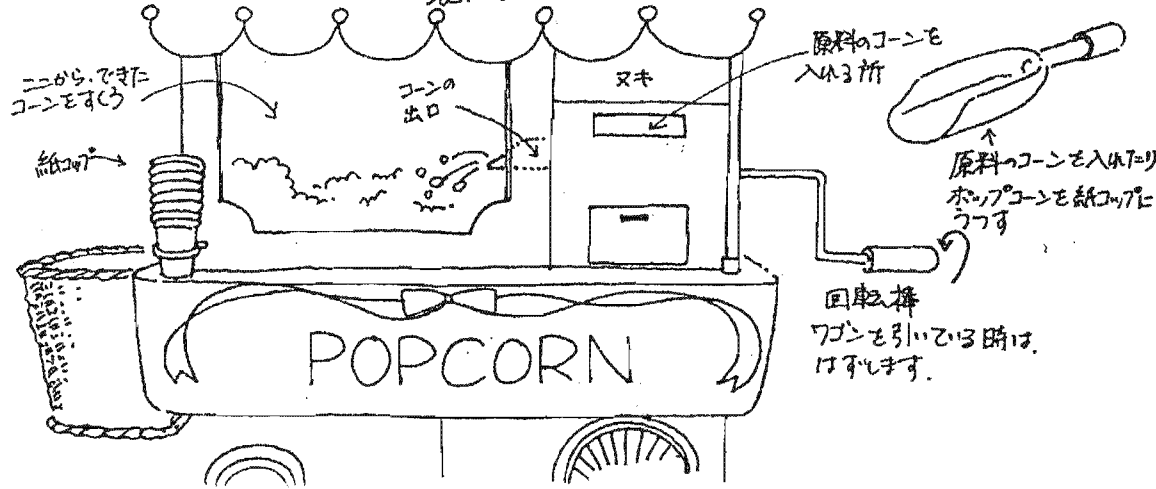

ニから、できたコーンを出す

コーンの出口

原料のコーンを入れる所

↑原料のコーンを入れて、ポップコーンを作ります。

回転棒ワゴンを引きこむ時は、はすします。

ローソクの からくり箱

ダイヤカット
半立体です (他の面も) 薄いので
ロングの時は 意識しなくてもいいです。
カゲ・ハイライト 適当によろしく。

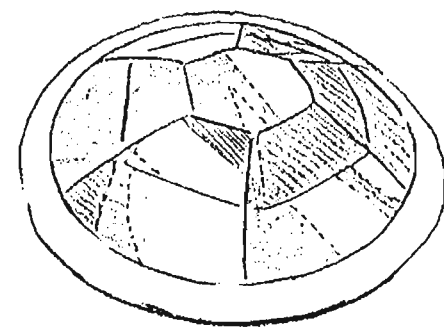
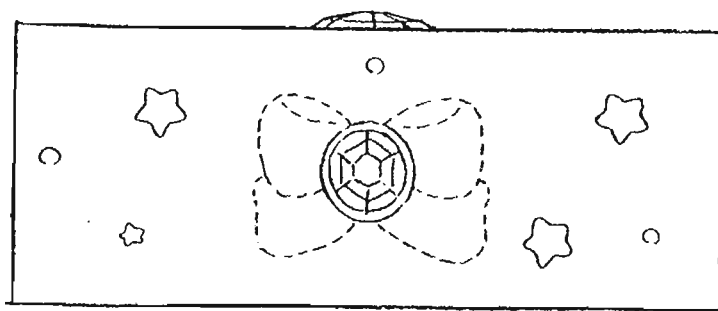
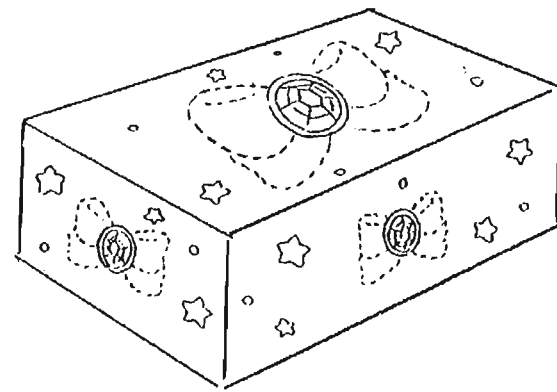
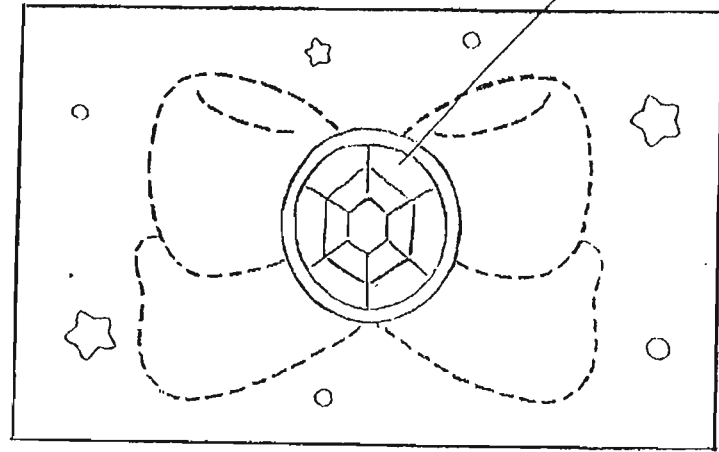

UP時

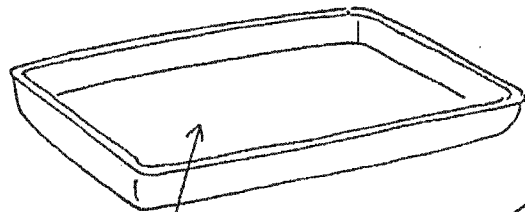
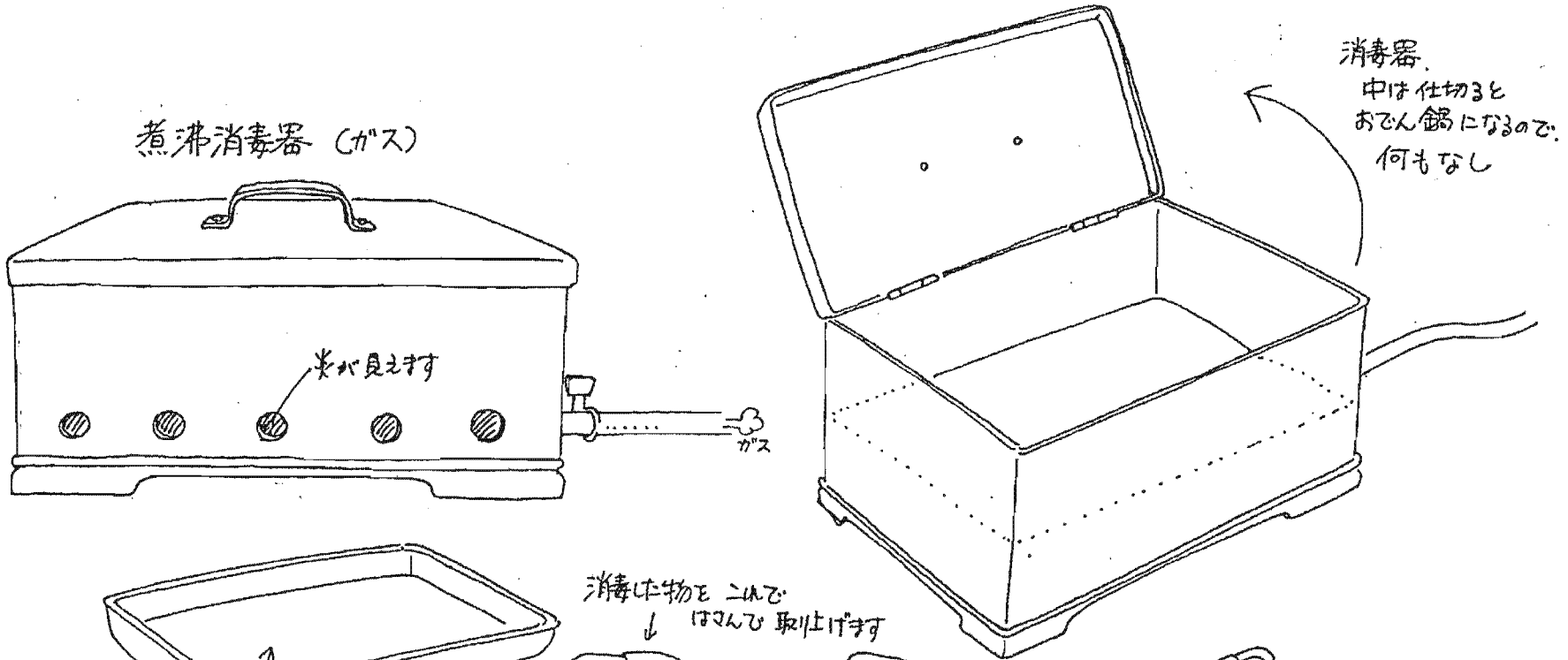

消毒した物をここに受け取ります

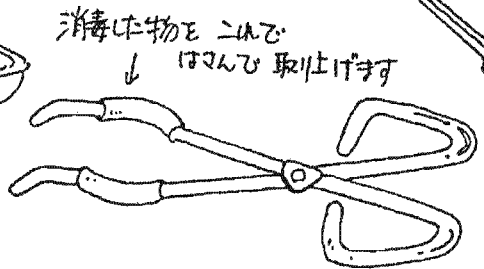

消毒した物をここで
↓
はさんで取上げます

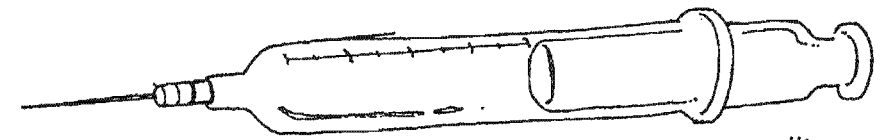

注射 用の時 ハイット等 フィーバー 捲き込んで下さい。

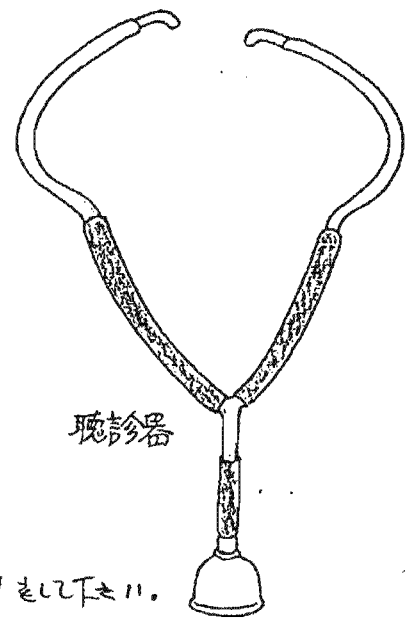

聴診器

パイククリニックの医療器具。 全体にステンレス製の材質なので ハイット等、味つけをして下さい。

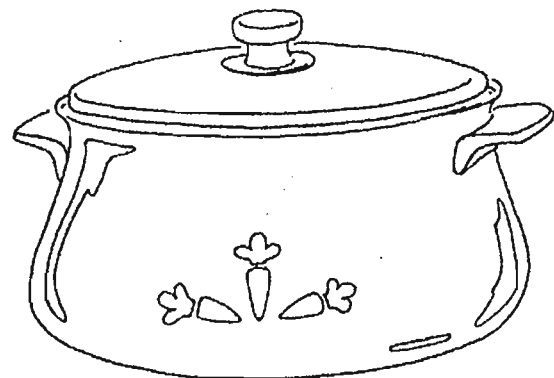

ホ-ロ-鍋

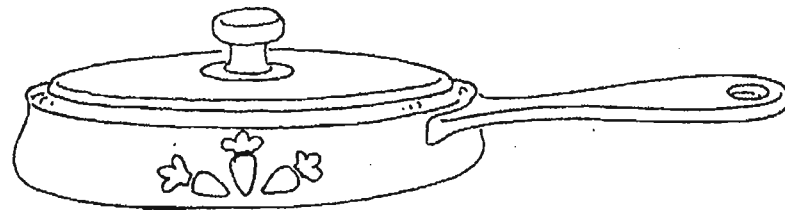

ホ-ロ-鍋



ボ-ウル (ステンレス)

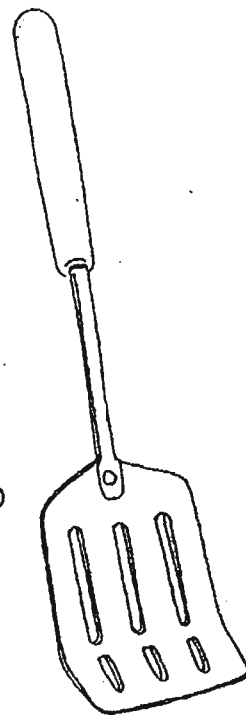

フライパン (かなり厚手。鍋つかみを使用しないと、やけどします)

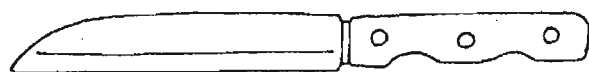
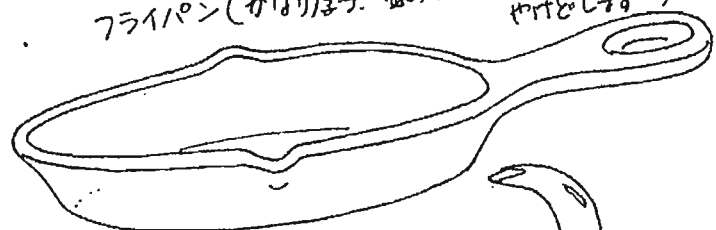

ペティナイフ (小ママです)



ホ-ロ-のやかん

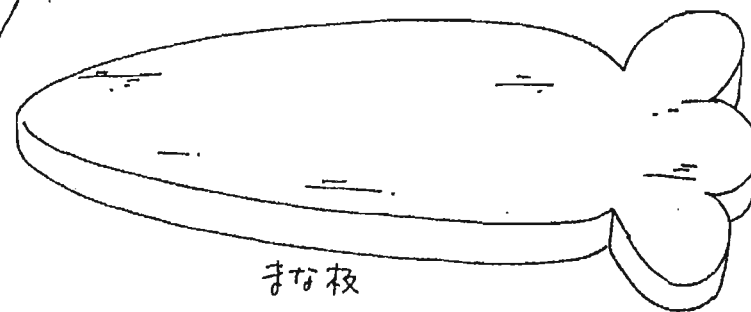

まな板

パパ家の台所用品

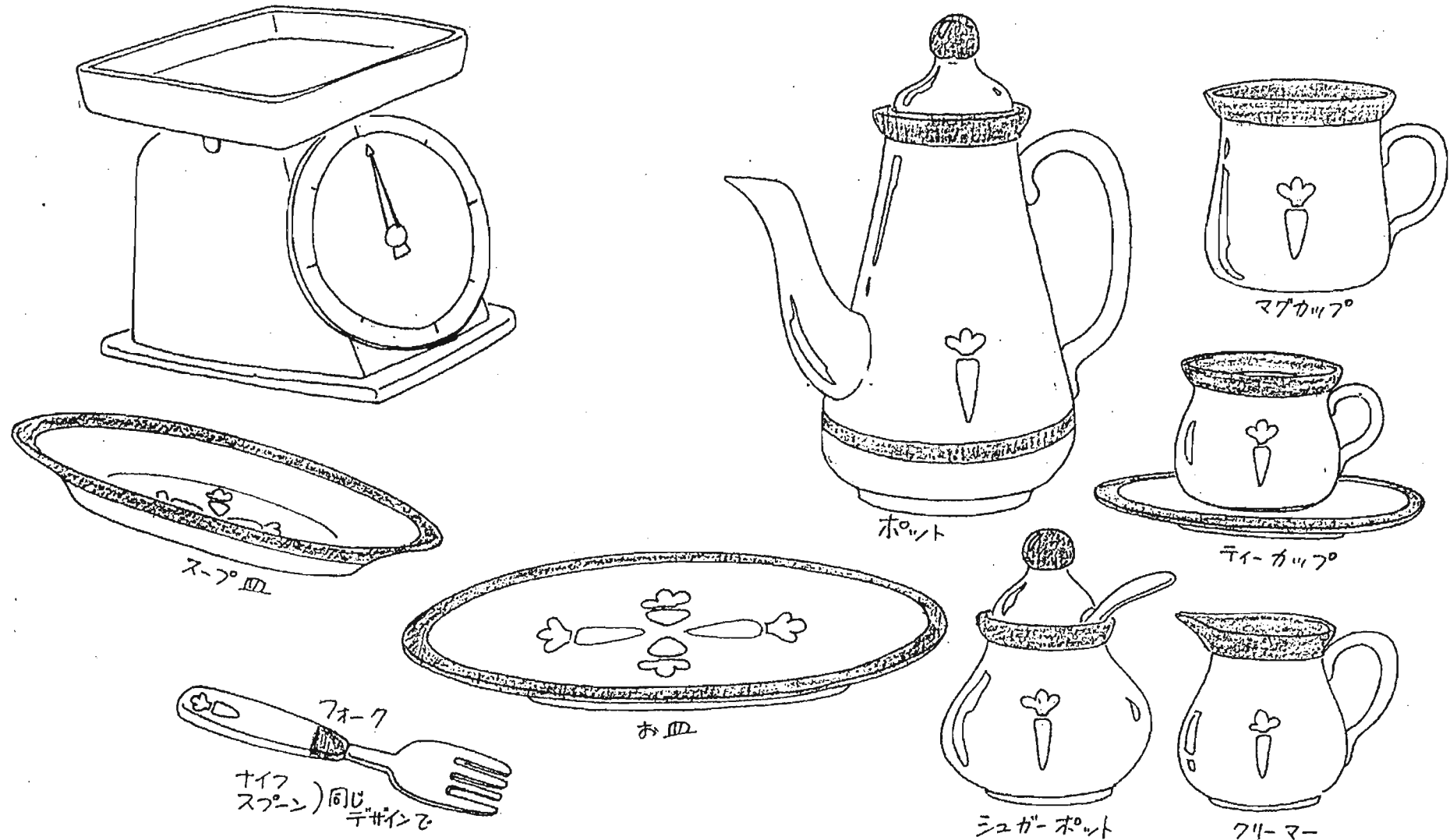

パイカ家の食器 (他の物も、このデザインに合わせよう)